

FORUM

LIGHTING SOLUTIONS



- Outdoor
- Lighting controls
- Kitchen & bathroom
- Indoor
- Commercial

EDITION 10.0

FORUM

LIGHTING SOLUTIONS

Forum Lighting Solutions is one of the U.K's largest suppliers of lighting and Smart controls.

Forum Lighting Solutions has been supplying industry leading lighting for domestic and commercial use for more than a decade . We have a wealth of experience and knowledge, combined with an in-depth range of aesthetically pleasing, low energy lighting solutions at competitive prices.



No part of this brochure may be reprinted or duplicated without our consent. All sizes and measurements are approximate but we try to make sure that they are as accurate as possible. In the interest of continuous production development Forum Lighting Solutions reserves the right to alter specification as necessary. Forum Lighting Solutions is a registered trademark.

CONTENTS

LIGHTING CONTROLS

4



KINETIC SWITCHES

- Kinetic Wireless Switches
- Kinetic RF/Wifi Receivers
- Kinetic Grid Switches
- Sensor

OUTDOOR LIGHTING

8



OUTDOOR

- Wall/Lanterns
- Ground/Deck Lights
- Post/Wall Lights
- Festoon Lights
- Deck Lights
- Security & Floodlights
- Work Lights
- Outdoor Heating
- Outdoor Sensors

116



SOLAR

- Post/Lanterns
- Ground Lights
- Wall Lights
- PIR Wall Lights
- Security & Floodlights
- Spike Lights
- Deck Lights
- Festoon Lights

142



PREMIUM OUTDOOR

- Post Lights
- Lanterns
- Bulkheads
- Wall Lights
- Guide Lights
- Ground/Spike Lights
- Security & Floodlights

KITCHEN & BATHROOM LIGHTING

170



BATHROOM

- Recessed/Downlights
- Ceiling/Wall Lights
- Spotlights
- Flush
- Wall Lights
- Bathroom Mirrors
- Bathroom Cabinets

232



KITCHEN

- Under Cabinet
- Konekt Plug + Play
- Track Lighting
- Plinth Lights

INDOOR LIGHTING

256

INLIGHT DECORATIVE

- Plaster Lights
- Spotlights
- Recessed/Downlights
- Pendant Cable Sets
- Picture Lights
- LED Lamps

COMMERCIAL LIGHTING

282



WORKSITE

- Security Lights
- Head Torches
- Hand Torches
- Site Lighting

322



COMMERCIAL

- LED Strips
- LED Strip Accessories
- Under Cabinet Lights
- Recessed/Downlights

INFO

344

- Marketing
- Lighting Terms
- Colour Temp Guide
- IP Rating
- Bathroom Zoning
- Index

Kinetic Switches

Self powered kinetic switches & receivers

The wireless switch uses micro-energy acquisition technology. Kinetic energy is generated to create and transmit a radio signal to the receiver which in turn, will switch lamps or other loads on or off.

There is no longer the constraint of wiring location and no need to install back boxes or cut holes into walls. The kinetic switch can be installed anywhere or placed to maximise convenience.

Lighting can be controlled manually by using the switch, smart phone or tablet using the Smart Life App or connecting it to a voice controlled device such as Amazon Alexa or Google Home.

The kinetic switches require no wiring or batteries which eliminates the need for installing back boxes, creating channels in walls and adjusting decor, thus speeding up the installation process and reducing labour time & costs.

The switch can be installed anywhere in the home, including the bathroom due to its IP65 rating. The switches can be screwed to the surface, or stuck on with the adhesive pads supplied. They can also be retro-fit onto existing back boxes as they are the same size as standard switches.

How kinetic switches work



Push to create kinetic energy



Convert kinetic energy to electricity



Send out signal



Receiver



Switch on/off light





NEW range of kinetic grid switches



	Code	Description	Colour	IP	Height	Width	Depth
 	CUL-44836		Black Chrome				
	CUL-44838	Kinetic Plated 1 Gang Grid Switch	Satin Brass	-	86mm	86mm	15mm
	CUL-44839		Satin Nickel				
 	CUL-44840		Black Chrome				
	CUL-44842	Kinetic Plated 2 Gang Grid Switch	Satin Brass	-	86mm	86mm	15mm
	CUL-44843		Satin Nickel				
 	CUL-44844	Kinetic Back Housing Plated Grid Switch Body	Black	IP20	86mm	86mm	15mm
	CUL-44845	Kinetic Back Housing Plated Grid Switch Body	White	IP20	86mm	86mm	15mm

Kinetic Switches & Accessories

Self powered kinetic switches & receivers

























	Code	Description	Colour	IP	Height	Width	Depth
	CUL-40031-65	1 Gang Kinetic Push Switch	Matt White	IP65	86mm	86mm	15mm
	CUL-40032-65	1 Gang Kinetic Push Switch	Matt Black	IP65	86mm	86mm	15mm
	CUL-40033-65	2 Gang Kinetic Push Switch	Matt White	IP65	86mm	86mm	15mm
	CUL-40034-65	2 Gang Kinetic Push Switch	Matt Black	IP65	86mm	86mm	15mm
	CUL-40035-65	3 Gang Kinetic Push Switch	Matt White	IP65	86mm	86mm	15mm
	CUL-40036-65	3 Gang Kinetic Push Switch	Matt Black	IP65	86mm	86mm	15mm
	CUL-40037	Kinetic Fob Switch	Grey	IP65	18mm	21mm	47mm
	CUL-40038	1 Channel Kinetic Switch RF Non-dim	White	IP20	32mm	32mm	64mm
	CUL-40039	1 Channel Smart RF & Wifi Kinetic Switch	White	IP20	32mm	32mm	64mm
	CUL-40040	1 Channel Smart Tuya RF & Wifi Kinetic Dim	White	IP20	75mm	52mm	24mm
	CUL-44766	Kinetic RF UK Plug	White	-	8mm	8mm	8mm

Kinetic Switches & Accessories

Self powered kinetic switches & receivers



	Code	Description	Colour	IP	Height	Width	Depth
 	CUL-44767	Kinetic Smart & RF UK Plug	White	-	8mm	8mm	8mm
 	CUL-42495	1 Gang Grid Kinetic Switch	White	IP20	86mm	86mm	15mm
 	CUL-42496	1 Gang Grid Kinetic Switch	Black	IP20	86mm	86mm	15mm
 	CUL-42497	1 Gang Grid Kinetic Switch - Dimmable	White	IP20	86mm	86mm	15mm
 	CUL-42498	2 Gang Grid Kinetic Switch - Dimmable	Black	IP20	86mm	86mm	15mm
 	CUL-44764	Slim Grid Kinetic Switch	Gloss White	IP20	53mm	25mm	32mm
 	CUL-44765	Slim Grid Kinetic Switch - Dimmable	Gloss White	IP20	53mm	25mm	32mm
 	CUL-42499	1 Gang Slimline Surround For Kinetic Switch	White	IP20	86mm	86mm	15mm
 	CUL-42500	1 Gang Slimline Surround for Slim Kinetic Switch	Black	IP20	86mm	86mm	15mm
 	CUL-42501	2 Gang Slimline Surround For Kinetic Switch	White	IP20	86mm	86mm	15mm
 	CUL-42502	2 Gang Slimline Surround For Kinetic Switch	Black	IP20	86mm	86mm	15mm





ZINK

OUTDOOR

Illuminate your home with our range of modern or traditional Outdoor lighting. Secure your home with low energy led security lights and warm those cooler nights with our range of ZINK outdoor heaters. We also offer a range of compatible sensors.

WALL/LANTERNS	10-70
POST LIGHTS	69
GROUND/DECK LIGHTS	70-76
FESTOON LIGHTS	77
SECURITY & FLOODLIGHTS	78-81
WORK LIGHTS	82-83
OUTDOOR HEATING	84-105
OUTDOOR SENSORS	106-115

REN

CCT Linear Wall Light



· Selectable colour temp

Code	Finish	Power (w)	Weight (kg)	Dimensions
ZN-44553-BLK	Black	10W	0.9	H300 x W90 x D45mm
ZN-44554-BLK	Black	16W	1.8	H600 x W90 x D45mm
ZN-44555-BLK	Black	24W	2.74	H900 x W90 x D45mm

BARDI

10W Linear Wall Light

IP54 NEW



 IP54 Rated
 Class 1
 0.59kg

Code	Finish	Power (w)	Dimensions
ZN-44223-BLK	Black	10W	H630 x W58 x D62mm

DAVEY

Caged Oval Bulkhead

IP44 NEW



 IP44 Rated
 Class 1
 1.3kg

Code	Finish	Power (w)	Dimensions
ZN-44230-GLD	Gold	9W	H245 x W160 x D105mm
ZN-44230-SIL	Silver	9W	H245 x W160 x D105mm

GALI

Caged Round Bulkhead

IP44

NEW



Code	Finish	Power (w)	Dimensions
ZN-44231-GLD	Gold	9W	H260 x W260 x D115mm
ZN-44231-SIL	Silver		

ANMO

CCT Globe Wall Light



IP54

NEW



Code	Finish	Power (w)	Dimensions
ZN-44218-ANTH	Anthracite	2 x 1w + 3w CCT	H132 x W104 x D100mm

ANAK

CCT Globe Wall Light



Code	Finish	Power (w)	Dimensions
ZN-44219-ANTH	Anthracite	2 x 1w + 3w CCT	H195 x W72 x D85mm

GAKI

Globe Wall Light



Code	Finish	Power (w)	Dimensions
ZN-44227-BLK	Aluminium/Glass Black	9W	H222 x W293 x D198mm

AKUMA

Ribbed Wall Light

IP44

NEW



Code	Finish	Power (w)	Dimensions
ZN-44411-BLK	Aluminium/Class Black	9W	H222 x W81 x 115mm

YUKI

Up and Down Wall Light

IP65

NEW



Code	Finish	Power (w)	Dimensions
ZN-43121-SST	Aluminium Stainless Steel	GU10 7W	H195 x W60 x D100mm

ANTAR

Up/Down Light

IP44

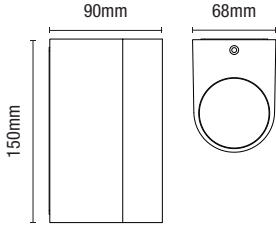

- IP44 rated
- Available in 2 finishes



Code	Finish	Lamp	Dimensions
ZN-20930-BLK	Black	2 x 7W max LED GU10	Proj90 W68 H150mm

ANTAR

Downlight

IP44

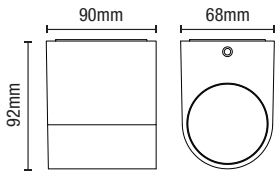

- IP44 rated
- Available in 2 finishes



Code	Finish	Lamp	Dimensions
ZN-29181-BLK	Black	1 x 7W max LED GU10	Proj90 W68 H92mm

BRAC

Downlight

IP54

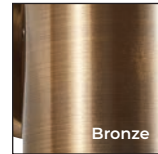
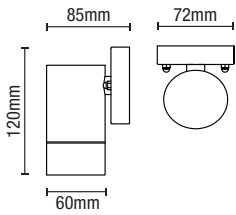

- Solid brass construction
- Available in 2 finishes



Code	Finish	Lamp	Dimensions
ZN-41101-BRNZ	Bronze	1 x 7W max LED GU10	W72 H120 Proj85mm
ZN-41101-RBRS	Brass		

BRAC

Up/Down Wall Light

IP54

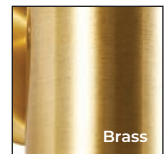
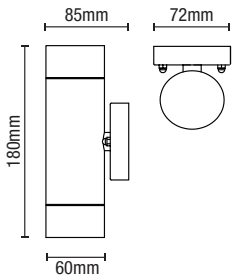

- Solid brass construction
- Available in 2 finishes



Code	Finish	Lamp	Dimensions
ZN-41102-BRNZ	Bronze	2 x 7W max LED GU10	W72 H180 Proj85mm
ZN-41102-RBRS	Brass		

MORRO

Long Up/Down Wall Light

IP65

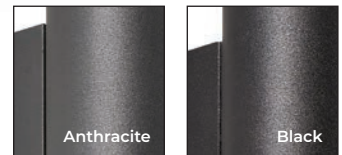
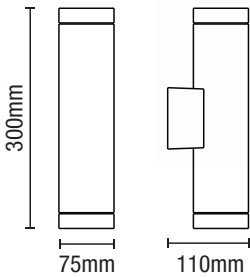

- Die-cast aluminium construction
- Available in 2 finishes



Code	Finish	Lamp	Dimensions
ZN-40001-BLK	Black	2 x 7W max LED GU10	W75 H300 Proj110mm
ZN-40001-ANTH	Anthracite		

BUDE

Coil LED Wall Light

540 LUMENS IP54

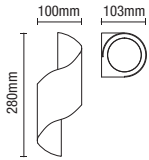

- Die-cast aluminium construction
- Wall mounted
- 9W LED
- K: 4000
- Lm: 460
- Lm/W 51.1

IP54 Rated 4000K CW Class 1

Code	Description	Finish	Power (w)	Colour (k)	Total Flux (lm)	Efficiency (lm/W)	Dimensions
ZN-42066-BLK	Bude Coil LED Wall Light	Black	12W	4000k	540	45	H280 W100 Proj103mm

CHESIL

Wall Lantern

IP44

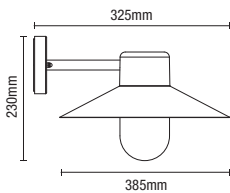

- Steel & glass construction

IP44 Rated Class 1 1.3kg

Code	Description	Finish	Lamp	Dimensions
ZN-42095-BLK	Chesil Wall Lantern	Black	1 x 10W max LED E27 GLS	W385 H230 Proj325mm

BREAN

Up/Down Wall Light

IP44



Stainless Steel

- Stainless steel construction



Code	Finish	Lamp	Dimensions
ZN-42019-SST	Stainless Steel	2 x 7W max LED GU10	W100 H300 Proj75mm

BEATA

Uplight

IP44

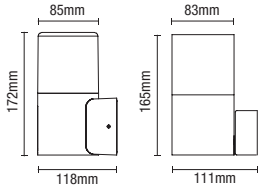

- Aluminium & PC construction
- Available in 2 round or square



Code	Shape	Lamp	Dimensions	Weight
ZN-41099-GRYSMK	Round	1 x 10W max LED E27 GLS	W85 H172 Proj118mm	0.448kg
ZN-41100-GRYSMK	Square	1 x 10W max LED E27 GLS	W83 H165 Proj111mm	0.53kg

BEATA

Up/Down Wall Light

IP44

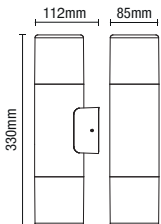

- Aluminium & PC construction



Code	Finish	Lamp	Dimensions
ZN-41711-GRYSMK	Grey/Smoke	2 x 10W max LED E27 GLS	W85 H330 Proj112mm

EOS

Up/Down Wall Light

IP54

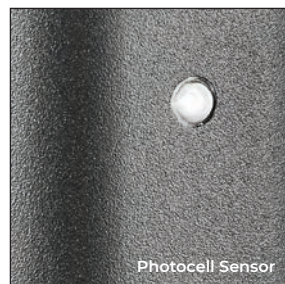
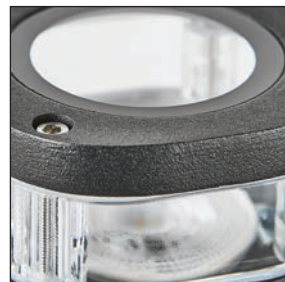

- Die-cast aluminium, PC and glass construction
- Available with or without photocell sensor





Code	Sensor	Lamp	Dimensions
ZN-32255-BLK	-	2 x 7W max LED GU10	W80 H225 Proj112mm
ZN-35072-BLK	Photocell		



LETO

Up/Down Wall Light



ZN-20941-SST-65

ZN-20941-POLSST-65

ZN-20941-BLK-65

ZN-20941-COP-65

ZN-20941-ANTH-65

ZN-20941-WHT-65

- Constructed from [304] stainless steel and clear glass
- Comes in 6 different finishes
- PIR & Photocell versions available



Code	Finish	Lamp	Dimensions
ZN-20941-SST-65	Stainless Steel	2 x 7W max LED GU10	H160 W60 Proj110mm
ZN-20941-POLSST-65	Polished Stainless		
ZN-20941-BLK-65	Black		
ZN-20941-WHT-65	White		
ZN-20941-ANTH-65	Anthracite		
ZN-20941-COP-65	Copper		



LETO

Adjustable Spotlight



ZN-26536-ANTH-65



ZN-26536-BLK-65



ZN-26536-WHT-65



ZN-26536-COP-65

- Constructed from [304] stainless steel and clear glass
- Comes in 5 different finishes



Code	Finish	Lamp	Dimensions
ZN-26536-SST-65	Stainless Steel	1 x 7W max LED GU10	H144 W60 Proj89mm
ZN-26536-ANTH-65	Anthracite		
ZN-26536-BLK-65	Black		
ZN-26536-WHT-65	White		
ZN-26536-COP-65	Copper		



LETO

Dual Mount Ground Spotlight



ZN-29180-SST-65



ZN-29180-BLK-65

- Constructed from [304] stainless steel and clear glass
- Screw in spike or deck mount included
- Available in 2 finishes



Code	Finish	Lamp	Dimensions
ZN-29180-SST-65	Stainless Steel	1 x 7W max LED GU10	H215 W60 Proj107mm
ZN-29180-BLK-65	Black		

LETO

Adjustable Twin Spotlight



ZN-34018-SST-65



ZN-34018-BLK-65

- Constructed from [304] stainless steel and clear glass
- Available in 2 finishes



Code	Finish	Lamp	Dimensions
ZN-34018-SST-65	Stainless Steel	2 x 7W max LED GU10	H215 W68 Proj107mm
ZN-34018-BLK-65	Black		

LETO

Up/Down Wall Light with PIR



IP65

NEW



ZN-29179-BLK-65



ZN-29179-ANTH-65

- Constructed from [304] stainless steel and clear glass
- Adjustable lux, sensitivity and timer
- Up to 8m detection distance
- Override function



PIR Sensor



IP65 Rated



Class 1



0.8kg

Code	Finish	Lamp	Dimensions
ZN-29179-SST-65	Stainless Steel		
ZN-29179-BLK-65	Black	2 x 7W max LED GU10	H215 W68 Proj107mm
ZN-29179-ANTH-65	Anthracite		

LETO

Up/Down Wall Light with Photocell Sensor



IP65

NEW

ZN-34022-SST-65



ZN-34022-BLK-65

- Constructed from [304] stainless steel and clear glass
- Photocell sensor
- Available in 2 finishes



Photocell Sensor



IP65 Rated



Class 1



0.67kg

Code	Finish	Lamp	Dimensions
ZN-34022-SST-65	Stainless Steel		
ZN-34022-BLK-65	Black	2 x 7W max LED GU10	H215 W68 Proj107mm

LETO

Downlight with PIR Sensor



IP65

NEW



ZN-37938-BLK-65



ZN-37938-ANTH-65

- Part of a full range of exterior fittings including, wall, ceiling, ground or spike
- Override function



Code	Finish	Lamp	Dimensions
ZN-37938-BLK-65	Black	1 x 7W max LED GU10	H118 W86Proj105.5mm
ZN-37938-ANTH-65	Anthracite		

LETO

Downlight

IP65

NEW



ZN-37940-ANTH-65



ZN-37940-BLK-65



ZN-37940-SST-65

- Part of a full range of exterior fittings including, wall, ceiling, ground or spike



Code	Finish	Lamp	Dimensions
ZN-37940-BLK-65	Black	1 x 7W max LED GU10	H118 W86 Proj105.5mm
ZN-37940-SST-65	Stainless Steel		
ZN-37940-ANTH-65	Anthracite		

MELO

Up/Down Wall Light



- Die-cast stainless steel construction
- 10W LED module (SMD)
- K: 4000
- Lm: 850
- Lm/W 85

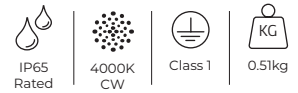

Code	Finish	Power (w)	Colour (k)	Total Flux (lm)	Dimensions
ZN-33460-BLK-65	Black	10W	4000k	850	H180 W86 Proj123mm

RAYU

Up/Down Wall Light

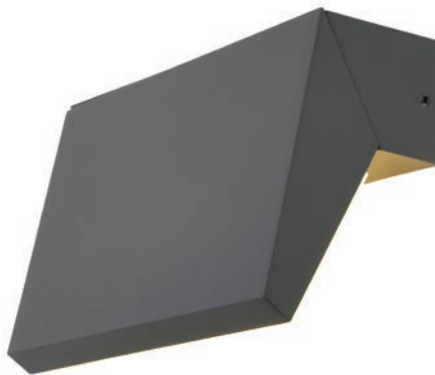

Code	Finish	Power (w)	Colour (k)	Total Flux (lm)	Dimensions
ZN-44245-ANTH	Anthracite	13W	4000k	500	H166 x W140 x D48mm

ECLIPSE

Up/Down Wall Light



Code	Finish	Power (w)	Colour (k)	Total Flux (lm)	Dimensions
ZN-44251-BLK	Black	12W	4000k	1190	H220 x W220 x D45mm

ALANI

Leaf Style Wall Light



Code	Finish	Power (w)	Colour (k)	Total Flux (lm)	Dimensions
ZN-43344-ANTH	Anthracite	9W	4000k	400	H285 x W100 x D150mm
ZN-43344-RST	Rust				

MANU

LED Up/Down Wall Light

620
LUMENS

IP54

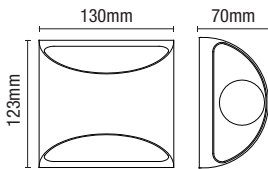

- Die-cast aluminium construction
- Wall mounted
- 8W LED
- K: 4000
- Lm: 620
- Lm/W 77.5



Code	Finish	Power (w)	Colour (k)	Total Flux (lm)	Efficiency (lm/W)	Dimensions
ZN-29993-BLK	Black	8W	4000k	620	77.5	H123 W130 Proj70mm

REIMS

Wall Light

700
LUMENS

IP54

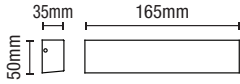

- Die-cast aluminium construction
- Opal polycarbonate diffuser
- 5.4W COB LED
- K: 4000
- Lm: 700
- Lm/W 130



Code	Finish	Power (w)	Colour (k)	Total Flux (lm)	Dimensions
ZN-38637-BLK	Black	5.4W	4000k	700	H50 W165 Proj35mm

CORTE

Wall Light

941
LUMENS

IP65

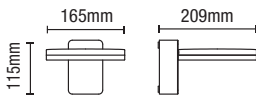

- Die-cast aluminium construction
- Opal diffuser
- 12W LED module (SMD)
- K: 4000
- Lm: 941
- Lm/W 78



Code	Finish	Power (w)	Colour (k)	Total Flux (lm)	Dimensions
ZN-38634-BLK	Black	12W	4000k	941	H115 W165 Proj209mm

MAUI

LED Up/Down Wall Light

620
LUMENS

IP54

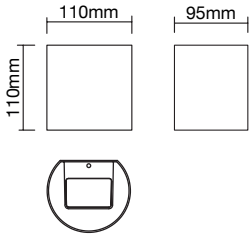

- Die-cast aluminium construction
- Wall mounted
- 8W LED
- K: 4000
- Lm: 620
- Lm/W 77.5

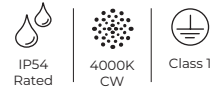

Code	Finish	Power (w)	Colour (k)	Total Flux (lm)	Efficiency (lm/W)	Dimensions
ZN-29995-BLK	Black	8W	4000k	620	77.5	H110 W110 Proj95mm

HANA

LED Up/Down Wall Light

620
LUMENS

IP54

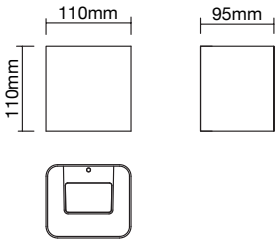

- Die-cast aluminium construction
- Wall mounted
- 8W LED
- K: 4000
- Lm: 620
- Lm/W 77.5



Code	Finish	Power (w)	Colour (k)	Total Flux (lm)	Efficiency (lm/W)	Dimensions
ZN-29996-BLK	Black	8W	4000k	620	77.5	H110 W110 Proj95mm

GORDA

LED Spotlight with Ground Spike

700
LUMENS

IP65



3 Different Mounting Options



Wall Light



Spotlight



Ground
Spike Light

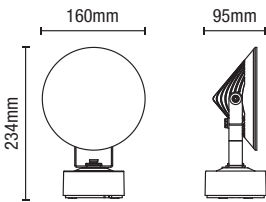

- Die-cast aluminium construction
- Includes ground spike
- Cable length 150mm
- 12W COB LED
- K: 4000
- Lm: 700
- Lm/W 58



Code	Finish	Power (w)	Colour (k)	Total Flux (lm)	Efficiency (lm/W)	Dimensions
ZN-35741-BLK	Black	12W	4000k	700	58	H234 W160 Proj195mm

STROUD

LED Up/Down Wall Light

UPTO
400
LUMENS

IP65



- Available in 2 sizes
- Die-cast aluminium

6W LED

- K: 4000
- Lm: 275
- Lm/W 45

12W LED

- K: 4000
- Lm: 400
- Lm/W 33

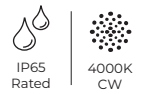
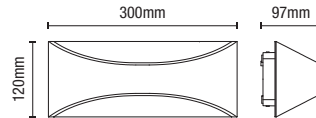
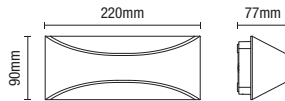

Code	Lamp	Lumen	Dimensions
ZN-31768-BLK	6W LED	275	H90 W220 Proj77mm
ZN-31767-BLK	12W LED	400	H120 W300 Proj97mm

VESOUL

Wall Light

IP43



- PIR sensor option available

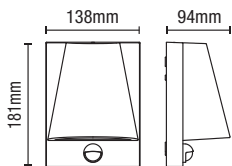

Code	Description	Finish	Lamp	Dimensions
ZN-38623-ANTH	Vesoul Wall Light	Anthracite	1 x 7W max LED GU10	Proj94 W138 H181mm
ZN-38624-ANTH	Vesoul Wall Light with PIR sensor			

PAU

Bulkhead

400
LUMENS

IP54

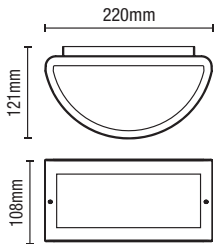

- Die-cast aluminium construction
- Opal polycarbonate diffuser
- 3 colour options available
- 10W LED module (SMD)
- K: 4000
- Lm: 500
- Lm/W 50



IP54
Rated



4000K
CW



Class 1



0.5kg

Code	Finish	Power (w)	Colour (k)	Total Flux (lm)	Dimensions
ZN-38621-BLK	Black	10W	4000k	500	H108 W220 Proj121mm

ONZA

LED Round Guide Light

IP54

NEW



Code	Finish	Power (w)	Colour (k)	Total Flux (lm)	Weight (kg)	Dimensions
ZN-44236-BLK	Black	3W	4000k	75	0.16	ø110 x D20mm
ZN-44237-BLK	Black	6W	4000k	270	0.29	ø160 x D30mm

PUYA

LED Square Guide Light

IP54

NEW

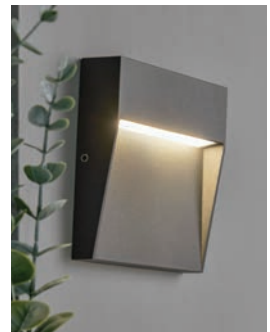

Code	Finish	Power (w)	Colour (k)	Total Flux (lm)	Weight (kg)	Dimensions
ZN-44238-ANTH	Anthracite	3W	4000k	75	0.18	H105 x W105 x D25mm
ZN-44239-ANTH	Anthracite	6W	4000k	370	0.35	H160 x W160 x D27

RENNES

LED Guide/Wall Light

280
LUMENS

IP54

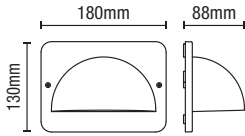

- Die-cast aluminium construction
- 3 colour options available
- 10W LED module (SMD)
- K: 4000
- Lm: 280
- Lm/W 28

IP54
Rated

4000K
CW

Class 1

0.4kg

Code	Description	Finish	Power (w)	Colour (k)	Total Flux (lm)	Dimensions
ZN-38622-BLK	Rennes LED Guide/Wall Light	Black	10W	4000k	280	H130 W180 Proj88mm

RENO

LED Recessed PIR Spotlight

390
LUMENS



- Polycarbonate construction
- Can detect day or night with adjustable LUX
- 6m Detection Distance
- 10 secs - 5min adjustable timer
- 8W LED module (SMD)

80mm
Cut-out

360°
Beam

4000K
WW

PIR
Sensor

Code	Power (w)	Colour (k)	Total Flux (lm)	Distance	Range	LUX (adjustable)	Time Delay (adjustable)	Dimensions
ZN-35690-WHT	8W	4000k	500	Max 6m	360°	<3-2000 LUX	Min.10sec±3sec Max.5min±1min	Dia:105 H48mm

MUTO

Adjustable Post Light

IP44

NEW



- GU10 7W
- Adjustable heights 30cm/60cm/90cm



Code	Finish	Lamp	Dimensions
ZN-44260-ANTH	Anthracite	GU10 7W	H1050 x W120 x D120mm
ZN-44260-BLK	Black		

MUTO

Fixed Downlight

IP65

NEW



- GU10 7W



Code	Finish	Lamp	Dimensions
ZN-44264-ANTH	Anthracite	GU10 7W	H144 x W70 x D118mm
ZN-44264-BLK	Black		

MUTO

Up/Down Wall Light



ZN-44263-ANTH



ZN-44262-BLK

· GU10 7W



Code	Finish	PIR	Lamp	Weight (kg)	Dimensions
ZN-44262-ANTH	Anthracite	-	GU10 7W	0.5	H182 x W70 x D117mm
ZN-44262-BLK	Black	-			
ZN-44263-ANTH	Anthracite	Yes	GU10 7W	0.6	H225 x W70 x D119mm
ZN-44263-BLK	Black	Yes			

FLEET

Square Up/Down Light

IP44

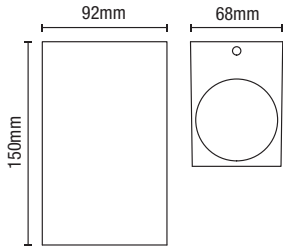

Code	Description	Finish	Lamp	Dimensions
ZN-31759-ANTH	Fleet Square Up/Down Wall Light	Anthracite	2 x 7W max LED GU10	Proj92 W68 H150mm

FLEET

Square Downlight

IP44

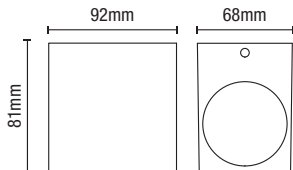

Code	Description	Finish	Lamp	Dimensions
ZN-31758-ANTH	Fleet Square Downlight	Anthracite	1 x 7W max LED GU10	Proj92 W68 H81mm

CANNES

Linear Wall Light

480
LUMENS

IP54

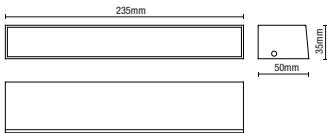

- Aluminium body with glass diffuser
- 9W LED module (SMD)
- K: 4000
- Lm: 408
- Lm/W 53

IP54
Rated

4000K
CW

Class 1

KG
0.45kg

Code	Description	Finish	Power (w)	Colour (k)	Total Flux (lm)	Dimensions
ZN-38636-ANTH	Cannes LED Linear Wall Light	Anthracite	9W	4000k	480	H50 W235 Proj33mm



LENS

Up/Down Wall Light

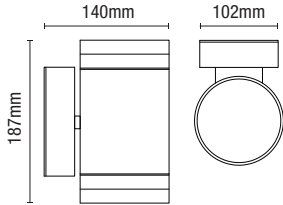

- IP44 rated
- Die-cast aluminium construction
- Anthracite finish
- Available with or without photocell sensor

- Photocell option available



Code	Sensor	Description	Lamp	Dimensions
ZN-29189-ATR	-	Lens Up/Down Wall Light	2 x 7W max LED GU10	H187 W102 Proj140mm
ZN-34042-ANTH	Photocell			

LENS

Downlight

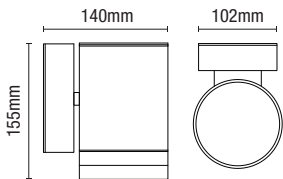

- IP44 rated
- Die-cast aluminium construction
- Anthracite finish
- Available with or without photocell sensor

- Photocell option available



Code	Sensor	Description	Lamp	Dimensions
ZN-29190-ATR	-	Lens Downlight	1 x 7W max LED GU10	H155 W102 Proj140mm
ZN-34043-ANTH	Photocell			



HELIX

Downlight

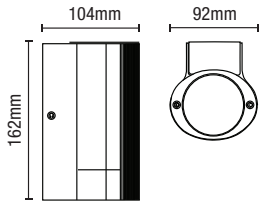

- IP44 rated
- Die-cast aluminium construction
Black ridged finish
- Available with or without photocell sensor



Code	Sensor	Description	Lamp	Dimensions
ZN-35593-BLK	-	Helix Down Light	1 x 7W max LED GU10	H162 W92 Proj104mm
ZN-35686-BLK	Photocell			

HELIX

Up/Down Wall Light

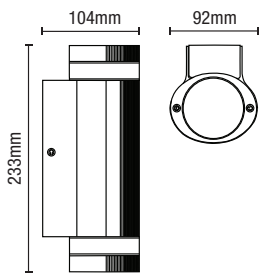

- IP44 rated
- Die-cast aluminium construction
Black ridged finish
- Available with or without photocell sensor



Code	Sensor	Description	Lamp	Dimensions
ZN-35594-BLK	-	Helix Up/Down Wall Light	2 x 7W max LED GU10	H233 W92 Proj104mm
ZN-35685-BLK	Photocell			

MIZAR

Up/Down Wall Light

1200
LUMENS

IP54

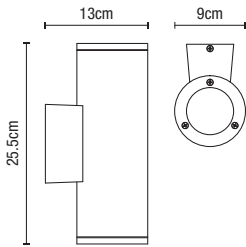

- Die-cast aluminium construction
- 20W LED module (SMD)
- Lm/W 60
- Hrs: 30,000



Code	Finish	Power (w)	Colour (k)	Total Flux (lm)	Dimensions
ZN-34019-ANTH	Anthracite	20W	4000k	1200	H255 W90 Proj130mm

MIZAR

Downlight

740
LUMENS

IP54

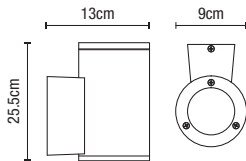

- Die-cast aluminium construction
- 10W LED module (SMD)
- Lm/W 74
- Hrs: 30,000



Code	Finish	Power (w)	Colour (k)	Total Flux (lm)	Dimensions
ZN-34020-ANTH	Anthracite	10W	4000k	740	H255 W90 Proj130mm

SKYE

Double Cone Up/Down Wall Light

IP44

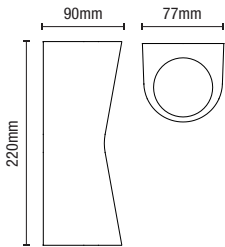

- Die-cast aluminium construction

Code	Finish	Lamp	Dimensions
ZN-29347-BLK	Black	2 x 7W max LED GU10	H220 W77 Proj90mm
ZN-29347-ANTH	Anthracite		

KEB

Wall Lantern

IP44

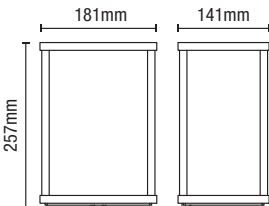

- Die-cast aluminium construction
- Contemporary styling
- Water glass effect

Code	Finish	Lamp	Dimensions
ZN-32069-BLK	Black	1 x 10W max LED E27 GLS	H257 W181 Proj141mm

OMEGA

Wall Lantern

IP44

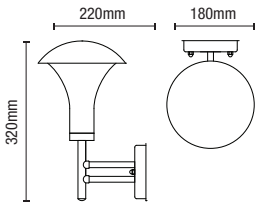

- Steel & PC construction
- Fluted lantern design



Code	Description	Finish	Lamp	Dimensions
ZN-15136-SST	Omega Wall Lantern	Stainless Steel	1 x 10W max LED E27 GLS	H320 W180 Proj220mm

DELTA

Slat Wall Lantern

IP44

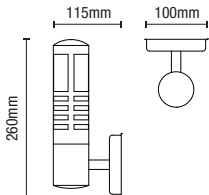

- Stainless steel construction
- Durable polycarbonate diffuser



Code	Description	Finish	Lamp	Dimensions
ZN-15871-SST	Delta Slat Wall Lantern	Stainless Steel	1 x 10W max LED E27 GLS	H260 W100 Proj115mm

GADA

Wall Light

IP44

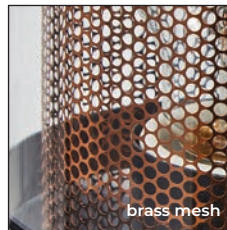
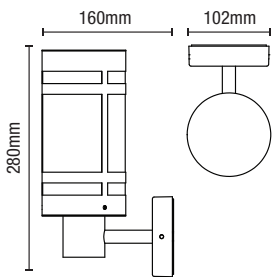

- Stainless steel [201] construction
- Available in 2 finishes
- Mesh insert design



Code	Description	Finish	Lamp	Dimensions
ZN-40004-BLK/BRS	Gada Wall Light	Black with Brass Mesh	1 x 10W max LED E27	W102 H280m Proj160mm
ZN-40004-BLK/SST		Black with Stainless Steel Mesh		

HESTIA

Glass Panel Box Lantern

IP44

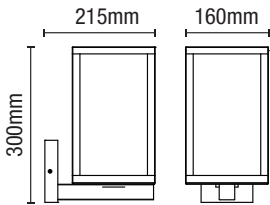

- Stainless steel construction
- Contemporary box lantern
- Available in 3 finishes



Code	Description	Finish	Lamp	Dimensions
ZN-38205-BLK	Hestia Glass Panel Box Lantern	Black	1 x 10W max LED E27 GLS	W160 H300 Proj215mm
ZN-38205-ANTH		Anthracite		

CHINON

Panel Light Box Lantern

IP44

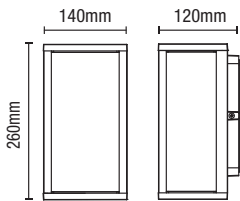

- Die-cast aluminium construction
- Contemporary styling



Code	Description	Finish	Weight	Lamp	Dimensions
ZN-38640-MBLK	Chinon Panel Box Lantern	Black	1.45kg	1 x 10W max LED E27 GLS	Proj140 W140 H260mm

MEMPHIS

Wall Lantern

IP44

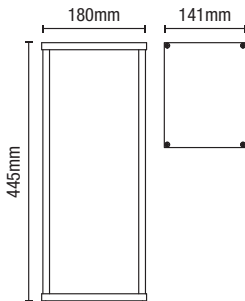

- Stainless steel construction
- Contemporary wall lantern
- Ribbed glass effect



IP44
Rated



Class 1



1.75kg

Code	Description	Finish	Lamp	Dimensions
ZN-38602-BLK	Memphis Wall Lantern	Black	1 x 10W max LED E27 GLS	Proj141 W180 H445mm

ARTEMIS

Box Lantern

IP44

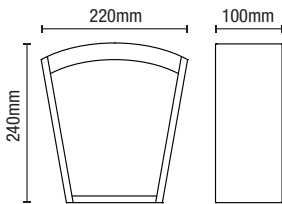

- Stainless steel construction
- Contemporary box lantern



Code	Finish	Lamp	Dimensions
ZN-20945-BLK	Black	1 x 10W max LED E27 GLS	Proj100 W220 H240mm

MINERVA

Box Lantern

IP44

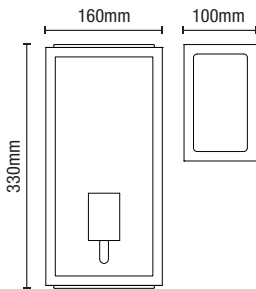

- Stainless steel construction
- Contemporary box lantern



Code	Description	Finish	Lamp	Dimensions
ZN-20944-BLK	Minerva Box Lantern	Black	1 x 10W max LED E27 GLS	W160 H330 Proj100mm
ZN_20944-ANTH		Anthracite		

CUBA

Box Lantern with Mesh Insert

IP44

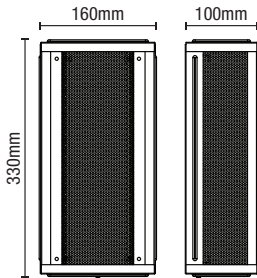

- Contemporary box lantern
- Mesh insert design



Code	Description	Finish	Lamp	Dimensions
ZN-40002-ANTH	Minerva Box Lantern with Mesh Insert	Anthracite/Silver Insert	1 x 10W max LED E27 GLS	W160 H330 Proj100mm
ZN-40002-BLK		Black/Brass Insert		



MINERVA

Box Lantern with PIR Sensor

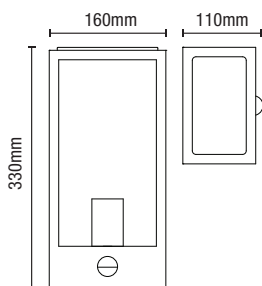

- Contemporary box lantern
- PIR Sensor
- 3-2000 LUX (adjustable)



Code	Description	Finish	Lamp	Dimensions
ZN-32070-BLK	Minerva Box Lantern	Black	1 x 10W max LED E27 GLS	Proj110 W160 H330mm
ZN-32070-ANTH	Minerva Box Lantern	Anthracite	1 x 10W max LED E27 GLS	Proj110 W160 H330mm



LEEK

Mini Fisherman's Lantern

IP44

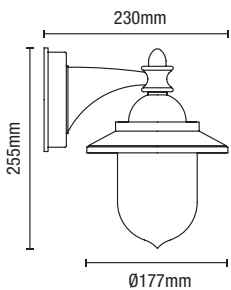

- Die-cast aluminium construction
- Clear polycarbonate diffuser
- Traditional styling



Class 1



0.75kg

Code	Finish	Lamp	Dimensions
ZN-31757-ANTH	Anthracite	1 x 10W max LED E27 GLS	Proj230 W177 H255mm



ERIS

Fisherman's Lantern

IP44

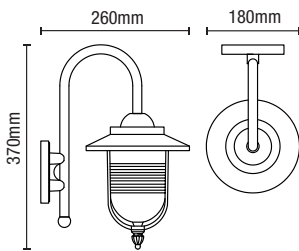

- Die-cast aluminium construction
- Traditional styling



Code	Finish	Lamp	Dimensions
ZN-20957-BLK	Black	1 x 10W max LED E27 GLS	Proj260 W180 H370mm

KEW

Wall Lantern

IP44

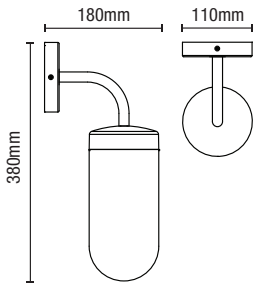

· Contemporary styling



Code	Finish	Lamp	Dimensions
ZN-31809-SST	Stainless Steel	1 x 10W max LED E27 GLS	Proj180 W110 H380mm

CERES

Wall Lantern

IP23

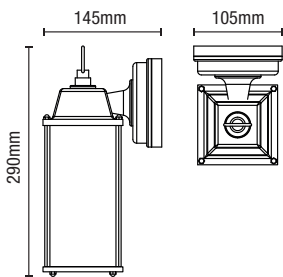

- Die-cast aluminium construction with glass panels
- Traditional styling



Code	Finish	Lamp	Dimensions
ZN-20955-BLK	Black	1 x 10W max LED E27 GLS	Proj145 W105 H290mm

PERSEI

Half Lantern

IP44

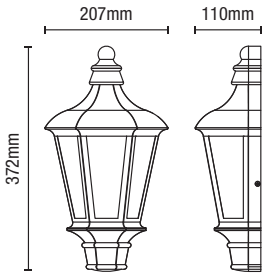

- IP44 rated
- Die-cast aluminium construction
- Traditional styled half lantern
- Available with or without photocell sensor



Code	Sensor	Lamp	Dimensions
ZN-33994-BLK	-	1 x 10W max LED E27 GLS	H372 W207 Proj110mm

WOKING

Wall Lantern

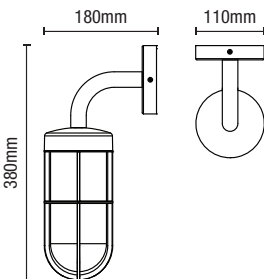

- Vintage styling
- Black satin finish



Code	Lamp	Dimensions
ZN-31807-TBLK	1 x 10W max LED E27 GLS	Proj180 W110 H380mm

CARNAC

Up or Down Wall Lantern

IP44

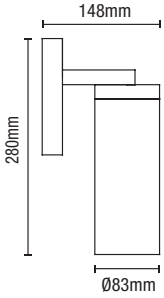

- Stainless steel construction
- Polycarbonate diffuser



Code	Finish	Lamp	Dimensions
ZN-38630-BLK	Black	1 x 10W max LED E27 GLS	Proj148 W83 H280mm

SIGMA

Slatted Wall Lantern

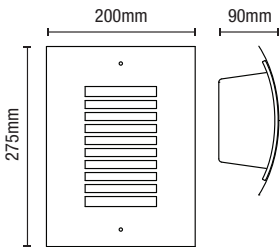

- IP44 rated
- Stainless steel construction
- Available in 2 finishes
- Available with or without PIR sensor



Code	Finish	Sensor	Lamp	Dimensions
ZN-25340-SST	Stainless Steel	-		
ZN-28708-SST	Stainless Steel	PIR	1 x 10W max LED E27 GLS	H275 W200 Proj90mm
ZN-28708-BLK	Black	PIR		

PERDITA

Curved Wall Lantern

IP44

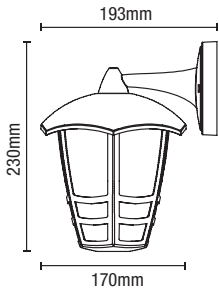

- Die-cast aluminium and polycarbonate construction
- IP44 rated
- Vintage style lantern
- Black satin finish



Code	Lamp	Dimensions
ZN-25463-BLK	1 x 10W max LED E27 GLS	Proj193 W170 H230mm

PERDITA

Half Lantern

IP44

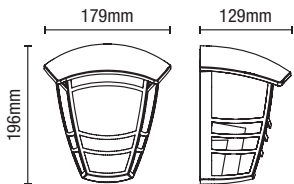

- Die-cast aluminium and polycarbonate construction
- IP44 rated
- Vintage style lantern
- Black satin finish



Code

Lamp

Dimensions

ZN-25464-BLK

1 x 10W max LED E27 GLS

Proj129 W179 H196mm

SCOUT



Surface Mount Ground Light

160
LUMENS

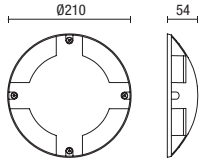
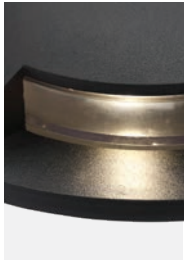
IP67



- Die-cast aluminium
- 4W LED module (SMD)
- K: 4000
- Lm: 160
- Lm/W 40

 IP67 Rated
 4000K CW
 Class 1

Code	Description	Finish	Power (w)	Colour (k)	Total Flux (lm)	Efficiency (lm/W)	Dimensions
ZN-29997-BLK	Scout Surface Mount Ground Light	Black	4W	4000k	100	40	Dia:210 Proj54mm

70
OUTDOOR

SCOUT

Surface Mount Ground Light

100
LUMENS

IP67

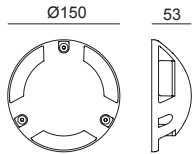
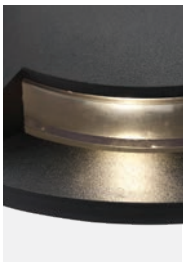

- Die-cast aluminium
- 3W LED module (SMD)
- K: 4000
- Lm: 100
- Lm/W 33

 IP67 Rated
 4000K CW
 Class 1

Code	Description	Finish	Power (w)	Colour (k)	Total Flux (lm)	Efficiency (lm/W)	Dimensions
ZN-35738-BLK	Scout Surface Mount Ground Light - 150mm	Black	3W	4000k	100	33	Dia:150 Proj53mm

PAN

Ground Light

IP67

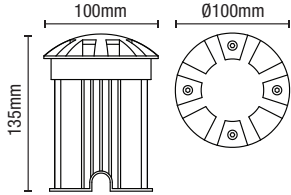

- Die-cast aluminium with glass lens
robust construction
- Min void 115mm
- Cable length 300mm

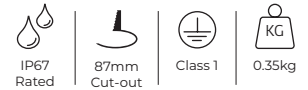

Code	Description	Finish	Lamp	Dimensions	Cutout
ZN-29184-BLK	Pan Ground Light	Black	1 x 7W max LED GU10	Dia:100 H135mm	Dia:87mm

PAN

Ground Light

IP67

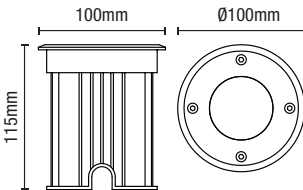

- Stainless steel with glass lens
robust construction
- Min void 115mm
- Cable length 300mm



Code	Finish	Lamp	Dimensions
ZN-20965-SST	Stainless Steel	1 x 7W max LED GU10	Dia:100 H115mm
ZN-20965-BLK	Black		



LAPIN

Recessed Deck Light Kit

250
LUMENS
PER LAMP

IP65

- Plug and play 24V garden deck light kit with add-ons available
- Add extra spikes to the circuit for added coverage - upto 8 spikes max
- 2m spacing between spikes as standard
- 6.2m between plug and first head
- Tough H05RN-F rubber cable
- IP65 rated (adaptor rated to IP20)
- Plug adapter requires IPX5 minimum housing if plugged in externally
- Add on photocell sensor available for auto on/off function at dusk/dawn
- 5m extension cable available



Code	Description	Cable Length	Power (w)	Colour (k)	Total Flux (lm)	Dimensions	Weight (kg)
ZN-41736	Lapin Recessed Deck 4 Light Kit	13.2m	4 x 3W	4000k	250lm per lamp	Dia. 41.5 H47mm	0.86kg
ZN-41737	Lapin Recessed Deck Add-on 2 Light Kit	4m	2 x 3W	4000k		Dia. 41.5 H49mm	0.278kg
ZN-41739	Lapin Add-on Photocell Sensor	0.4m	-	-	-	Dia: 52mm	0.048kg
ZN-41738	Lapin Add-on Extension Cable	5m	-	-	-	L:5000mm	0.102kg

LAPIN

Garden Spike Light Kit

Plug
+
Play

240
LUMENS
PER LAMP

IP65

- Plug and play 24V garden spike light kit with add-ons available
- Lamps can be deck mounted or come with a ground spike
- Add extra spikes to the circuit for added coverage - upto 8 spikes max
- 2m spacing between spikes as standard
- 6.2m between plug and first head
- Tough H05RN-F rubber cable
- IP65 rated (adaptor rated to IP20)
- Plug adapter requires IPX5 minimum housing if plugged in externally
- Add on photocell sensor available for auto on/off function at dusk/dawn
- 5m extension cable available



Code	Description	Cable Length	Power (w)	Colour (k)	Total Flux (lm)	Dimensions	Weight (kg)
ZN-41732	Lapin Garden Spike 4 Light Kit	13.2m	4 x 3W	4000k	240lm per lamp	Dia. 60 H150mm	0.93kg
ZN-41733	Lapin Garden Spike Add-on 2 Light Kit	4m	2 x 3W	4000k		Dia. 60 H150mm	0.34kg
ZN-41739	Lapin Add-on Photocell Sensor	0.4m	-	-	-	Dia: 52mm	0.048kg
ZN-41738	Lapin Add-on Extension Cable	5m	-	-	-	L:5000mm	0.102kg





LAPIN

Pathway Light Kit

Plug
+
Play

250
LUMENS
PER LAMP

IP65

- Plug and play 24V garden pathway light kit with add-ons available
- Add extra spikes to the circuit for added coverage - upto 8 spikes max
- 2m spacing between spikes as standard
- 6.2m between plug and first head
- Tough H05RN-F rubber cable
- IP65 rated (adaptor rated to IP20)
- Plug adapter requires IPX5 minimum housing if plugged in externally
- Add on photocell sensor available for auto on/off function at dusk/dawn
- 5m extension cable available



IP65
Rated

Class 3

Code	Description	Cable Length	Power (w)	Colour (k)	Total Flux (lm)	Dimensions	Weight (kg)
ZN-41734	Lapin Pathway 4 Light Kit	13.2m	4 x 3W	4000k	250lm per lamp	Dia. 35 H230mm	0.70kg
ZN-41735	Lapin Pathway Add-on 2 Light Kit	4m	2 x 3W	4000k		Dia. 35 H230mm	0.34kg
ZN-41739	Lapin Add-on Photocell Sensor	0.4m	-	-	-	Dia: 52mm	0.048kg
ZN-41738	Lapin Add-on Extension Cable	5m	-	-	-	L:5000mm	0.102kg

BARU

RGB Deck light kit



75
OUTDOOR

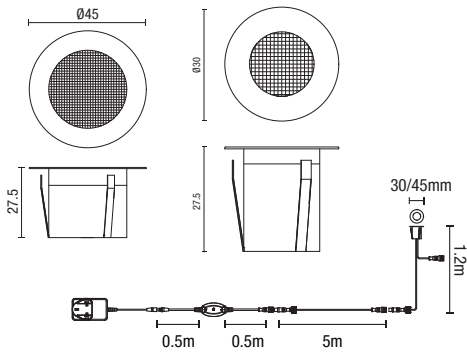

- [304] Stainless steel construction
- 1.2m cable between each head
- 10 x 0.5W LED module (SMD)
- 1 x 12V IP20 inline transformer with 5m cable
- Easy to install
- Smart wi-fi capability



Code	Description	Finish	Power (w)	Colour	Total Flux (lm)	Dimensions
ZN-40065	Baru RGB Deck Light Kit	Stainless Steel	10x 0.5W	RGB	55	Dia:30 Proj:1200mm

PLUG + SOCKET

Cable Connectors

IP68



Code	Description	Size
ZN-41157	32A, 3 Pole, IP68 Cable Connector (1 x fast-fit connector)	H30 x L:95 x D30mm
ZN-41158	16A, 3 Pole, IP68 T 3-Way Cable Connector (3 x fast-fit connectors)	H30 x L:150 x D30mm

OHIO

Circular Decking Light

NO DRIVER REQ. 20 LUMENS IP65

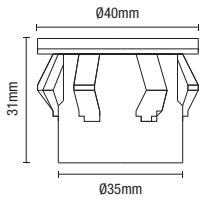

- Mains connected - no driver required
- Brushed steel finish with opal polycarbonate diffuser
- Available in 3000K/6000K
- 1m cable included
- 0.5W LED module (SMD)
- Lm: 20

IP65 Rated 35mm Cut-out 1M Cable Class 2 0.13kg

Code	Lamp	Kelvin	Lumen	Dimensions
CUL-26465-WW	0.5W LED	3000	20	Dia:40mm
CUL-26465	0.5W LED	6000	20	Dia:40mm

HARDY

20 x E27 Lampholder Festoon

Plug
+
play

IP44

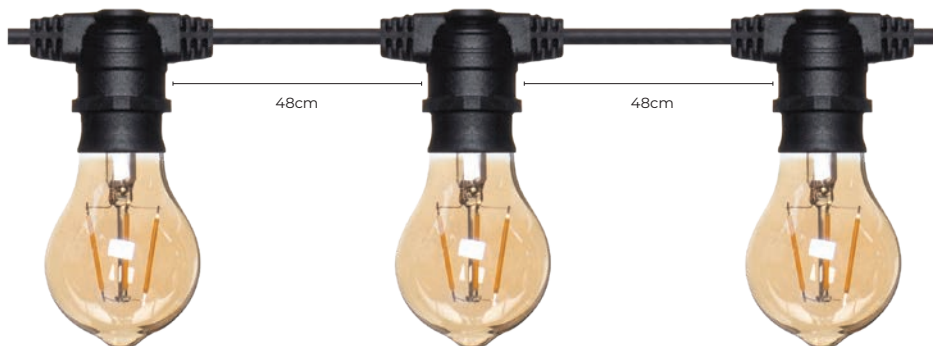

Loop multiple festoons together with weatherproof connectors

- Plug and play - no driver required
- Rubber H05RN-F 2 x 1.0mm² Cable
- Lamps not included
- 11.4m total length
- 5m from plug to first lampholder
- 48cm spacing between each head
- Connect multiple festoon lights together
- Suitable bulbs are shown on P.352



Code	Finish	Lamp	Dimensions
ZN-41106	Black Rubber	20 x 10W max LED E27 GLS	LengthH 11.4m
ZN- 41126		22 x 1w E27 LED lamps set 2700k clear	



GIGI

Eyelid Bulkhead



78 | OUTDOOR

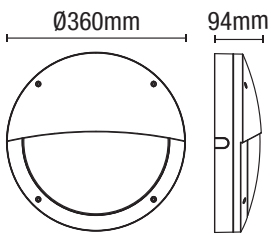

- Die-cast aluminium with polycarbonate diffuser
- Colour changing technology
- Switch between 3000K/4000K/6000K
- 20W LED module (SMD)
- 50,000 hours lifetime



Code	Finish	Power (w)	Colour (k)	Total Flux (lm)	Efficiency (lm/W)	Dimensions
ZN-39746-BLK	Black	20W	CCT	1700	85	Dia:360 Proj94mm

LYNN

PIR Twin Security Spotlight



1624
LUMENS

IP65



- Polycarbonate construction
- PIR sensor with adjustable LUX sensitivity and timer
- 5-12m Detection Distance
- 20W LED module (SMD)
- Lm/W 81
- Hrs: 20,000



IP65
Rated



4000K
CW



PIR
Sensor



Class 2



0.5kg

Code	Finish	Power (w)	Colour (k)	Total Flux (lm)	Dimensions
ZN-35688-BLK	Black				
ZN-35688-DGRY	Dark Grey	20W	4000k	1624	H205 W305 Proj135mm
ZN-35688-WHT	White				

SIROCCO

PIR Twin Security Spotlight



480
LUMENS

IP44

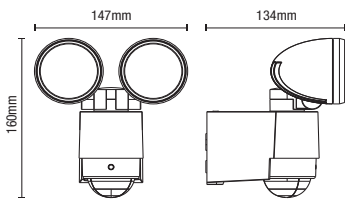

- Polycarbonate construction
- PIR sensor with adjustable LUX sensitivity and timer
- 5-12m Detection Distance
- Hrs: 20,000



Code	Finish	Power (w)	Colour (k)	Total Flux (lm)	Efficiency (lm/W)	Dimensions
ZN-23454-BLK	Black	6W	6000k	480	80	H160 W147 Proj134mm
ZN-23454-WHT	White					

FELIS

LED Battery Operated Twin Spotlight



200
LUMENS

IP44

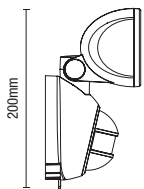
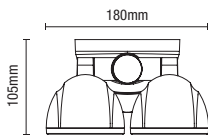

- Battery-operated for use on buildings without mains electricity supply
- Requires 4x AA batteries (not supplied)
- Concealed auto or off switch
- Adjustable swivel heads
- Up to 10m detection distance

Code	Power (w)	Colour (k)	Total Flux (lm)	Batteries
ZN-30508-BLK	2W LED	5000k	200	4 x 1.5V AA (not included)

RECHARGEABLE

Worklight

UPTO
1400
LUMENS

IP54



- Tough aluminium construction
- Rotates 360° on base
- Non-slip carry handle
- 40,000 hours LED lifetime
- Fully charged in 4-5 hours
- Supplied with power adapter and in-car charger
- Extendable tripod available which extends up to 1.58m for use with both 10/20W models

- Power adapter and in-car charger



Code	Power (w)	Total Flux (lm)	Efficiency (lm/W)	Colour (k)	Charge Time (h)	Run Time (h)	Dimensions
ZN-31385	10W	700	70	6000k	4-5 Hours	4 Hours	L:135 W:120 H:255mm
ZN-31386	20W	1400	70			8 Hours	L:160 W:160 H:300mm

TWIN LED

Worklight with Tripod

3000
LUMENS

IP65



- Durable rubber casing
- Heavy duty extendable tripod up to 1.6m
- 1.8m H07RN-F cable
- 2 x 20W LED module (SMD)
- K: 6000
- Lm: 3000
- Lm/W 75
- Hrs: 20,000



IP65
Rated



6000K
DW



1.8M
Cable



Class 1



3.4kg

Code	Voltage	Lamp	Lumen	Dimensions
ZN-34870	220-240V	2 x 20W LED	3000	Dia:1000 H1600mm

ZINK

OUTDOOR HEATING

An extensive range of Zink Radiant Heaters offering a solution for most outdoor settings.



CORAL

Outdoor Pedestal Heater

IP34



- Single heat setting
- Aluminium cover, size: 420 x 420mm
- Heating element: Carbon tube
- Outdoor use only
- Pull-string switch control
- Tip over switch

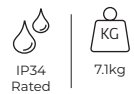

Code	Finish	Power (w)	Dimensions
ZR-38155-SIL	Silver	1500	H1960 Dia:500mm

BLAZE

Stand for wall mount heaters



- Adjustable height

Code	Weight	Dimensions
ZR-32302-BLK	15.8kg	H1700 Dia:410mm

BLAZE

Wall Mounted Patio Heater

IP34

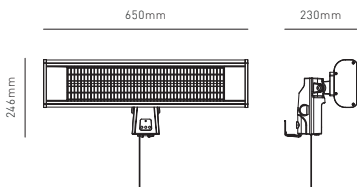

- Pull ON/OFF switch
- Wall or stand mounted
- Tip over safety switch
- Heat coverage approx 12m²
- IP44 rating
- Outdoor use only
- Stand available separately (ZR-32302)



Code	Finish	Power (w)	Dimensions
ZR-32298-BLK	Black	1800	H246 W650 Proj230mm



BLAZE

Wall Mounted Patio Heater with LED Lights

IP44

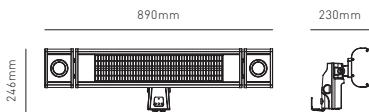

- Remote control operated
- Wall or stand mounted
- Tip over safety switch
- Heat coverage approx 12m²
- IP44 rating
- Outdoor use only
- 2 x 1W integrated LED lamps
- Stand available separately (ZR-32302)

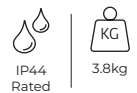

Code	Finish	Power (w)	Dimensions
ZR-32299-BLK	Black	1800	H246 W890 Proj230mm



BLAZE

Wall Mount Patio Heater Variable Watt

3
HEAT
SETTINGS

IP24

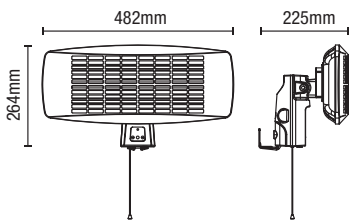

- Pull switch
- 3 variable heat settings
- Wall or stand mounted
- Tip over safety switch
- Heat coverage approx 12m²
- IP24 rating
- Outdoor use only
- Stand available separately (ZR-32302)



3 Heat
Settings



IP24
Rated



1.8kg

Code	Finish	Power (w)	Dimensions
ZR-32297-BLK	Black	2000	H264 W482 Proj225mm

MARL

Outdoor Heaters

IP34



Pendant Heater

- ON/OFF switch
- Remote control operated
- Integrated LED light
- Heat coverage approx 20m²
- IP34 rating
- Outdoor use only

Floor Standing Heater

- Pull string switch
- 2 heat setting
- Tip over safety switch
- Heat coverage approx 20m²
- IPX4 rating
- Outdoor use only



Code	Description	Finish	Power (w)	Dimensions	Weight
ZR-38532-SIL	Marl Pendant Heater	Silver	2000	H320 Dia:530mm	2.3kg
ZR-38831-SIL	Marl Floor Standing Heater	Silver	2000	H2000 Dia:500mm	7.8kg

CORAL

Pendant Heater

IP34



- Pull string switch
- Heat coverage approx 15m²
- IP34 rating
- Outdoor use only



Code	Finish	Power (w)	Dimensions
ZR-38529-SIL	Silver	1500	H320 Dia:530mm

Onyx

Outdoor Heaters

IP34

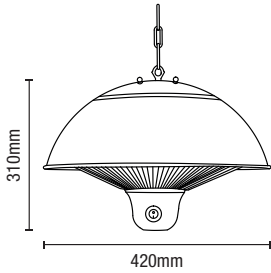

Pendant Heater

- Remote control operated
- Integrated LED light
- Heat coverage approx 15m²
- IP34 rating
- Outdoor use only

Floor Standing Heater

- Pull string switch
- Single heat setting
- Tip over safety switch
- Heat coverage approx 15m²
- IP34 rating
- Outdoor use only



Code	Description	Finish	Power (w)	Dimensions	Weight
ZR-38833-BLK	Onyx Pendant Heater	Black	1500	H310 Dia:420mm	2.6kg
ZR-38834-BLK	Onyx Floor Standing Heater	Black	1500	H2000 Dia:500mm	8.4kg

OPAL

Outdoor/Indoor Pedestal
Heater

3
HEAT
SETTINGS

IP44



- Free standing
- 3 heat settings
- Heat coverage approx 12m²
- Heater head W500 x H250mm
- Heating element: Carbon tube
- Outdoor use only
- Waterproof: IP44
- Pull-string switch control
- Tip over switch
- Stand included



3 Heat
Settings



IP44
Rated



8.4kg

Code	Finish	Power (w)	Dimensions
------	--------	-----------	------------

ZR-38156-BLK	Black	2000	H1800-2100 Dia:500mm
--------------	-------	------	----------------------

JET

Outdoor Ceiling Mount Heater

3
HEAT
SETTINGS

IP55

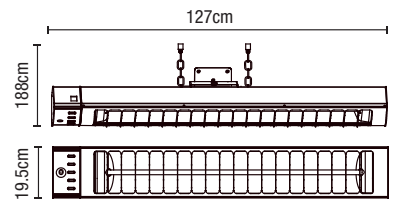

- Remote control
- Hanging and wall mount type
- 3 heat settings - 900/1900/2800W
- Heat coverage approx 25m²
- 4 Hour timer
- 1.9M Cable
- Black brushed aluminium finish
- PIR economy function



3 Heat
Settings



IP55
Rated



6.5kg

Code	Finish	Power (w)	Dimensions
ZR-37443-BLK	Black	2800	H195 W1270 D140mm

GLOW

Wall Mounted Heater

3
HEAT
SETTINGS

IP65

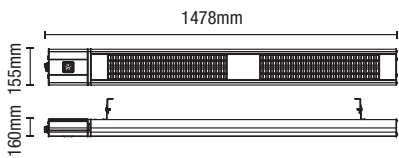

- Ideal for commercial applications
- Remote control operated
- Variable heat setting
- 1-9 Hour Timer
- Heat coverage 20m²
- IP65 rating
- Outdoor use only

3 Heat Settings
 IP65 Rated
 5.25kg

Code	Finish	Power (w)	Dimensions
ZR-32301-BLK	Black	3000	H155 W1470 Proj75 mm

INDOOR/OUTDOOR

Wall Mount Heater with 24Hr Timer

3
HEAT
SETTINGS

IP55

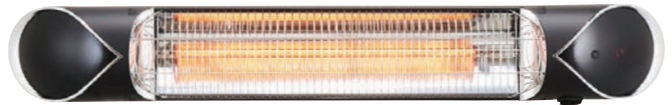

- Ideal for indoor/outdoor use
- Remote control operated
- 3 variable heat settings
- 0-24 Hour Timer
- Heat coverage approx 12m²
- IP55 rating



3 Heat
Settings



IP55
Rated



2.62kg

Code	Finish	Power (w)	Dimensions
ZR-32328-BLK	Black	2000	H140 W900L:90mm

FLINT

Wall Mount Heater with Bluetooth Speaker

IP65



- Bluetooth speaker
- Remote control operated
- Heat coverage approx 12m²
- 1.5M HO7RN-F 3G1.5MM cable
- ON/OFF and power adjust for remote
- IPX5
- Outdoor use only



Code	Finish	Power (w)	Dimensions
ZR-37444-BLK	Black	2000	H180 W808 Proj280mm

HARRY

Outdoor Portable Table Heater

IP45

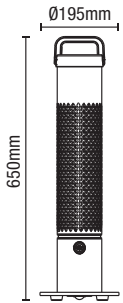

- Carbon fibre tube
- ON/OFF switch
- Fabric-flocked vents area
- 1.8M cable
- Heat coverage approx 4m²
- IP45 rated



Code	Finish	Power (w)	Dimensions
ZR-37441-BLK	Matt Black	1200	H650 Dia:195mm



BLAZE

Standing Patio Heater

3
HEAT
SETTINGS

IP55



- Remote control operated
- Tip over safety switch
- 3 variable heat settings
- Heat coverage approx 10m²
- IP55 rated
- Outdoor use only

3 Heat
Settings

IP55
Rated

KG
7.8kg

Code	Finish	Power (w)	Dimensions
ZR-32300-BLK	Black	1600	H1110 Dia:280mm



AMBER

Floor Standing Outdoor Heater

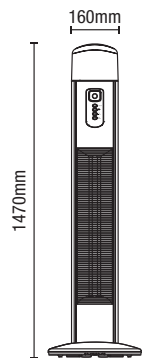
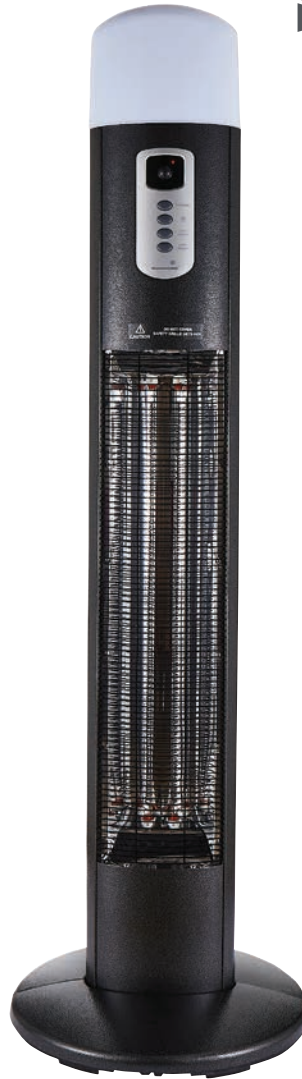

- 2 heat settings: 1480/2960W
- Carbon fibre heating technology
- Large, effective heating area of up to 30m²
- PIR economy system
- IP55 rated
- 12W LED Colour changing light: Warm/Daylight/Cool
- Gun metal hammered finish with fabric flocked grille with storage cover
- Magnetic remote control



2 Heat Settings



IP55 Rated



KG

21.3kg

Code	Finish	Power (w)	Dimensions
ZR-37442-GMTL	Gun Metal	3000	H1700 Dia:500mm

TOPAZ

2 x 800W Parasol Heater

IPX3

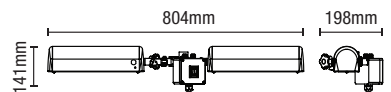

- Steel lamp case
- 1.4M HO5RN-F 3G1.0MM cable
- Heat coverage approx 10m²
- IPX3 rated
- BS1363 plug
- Ruby quartz halogen lamps
- Each lamp independently switched
- Outdoor use only



Code	Finish	Power (w)	Dimensions
ZR-37448-BLK	Black	2 x 800	H2141 W804 Proj198mm

RUBY

4 x 450W Parasol Heater

IPX3



- Aluminium diecast lamp case
- 1.4M HO5RN-F 3G1.0MM cable
- Heat coverage approx 12m²
- IPX3 rated
- BS1363 plug
- Ruby halogen lamp
- ON/OFF switch
- Outdoor use only

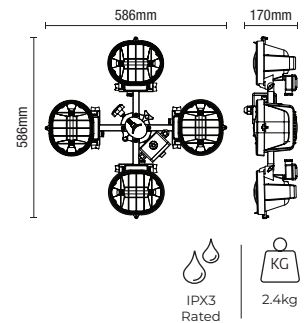

Code	Finish	Power (w)	Dimensions
ZR-37445-BLK	Black	4 x 450	H170 W586 Proj586mm

TERA

Recessed Real Presence Sensor

IP54

NEW



- Human presence sensor
- Can detect human breath
- Light stays on when people are detected
- When people leave, the lights will go out



Code	Finish	Installation Height	Distance	Range	LUX	Max Rated Load	Dimensions
ZN-44371	White	1.5-3.5m	2.5-3m	360°	3-2000	1200W	H76 x W70 x D70mm

CETA

Surface Mounted Corridor PIR Sensor



IP20

NEW



Code	Finish	Installation Height	Distance	Range	LUX	Max Rated Load	Dimensions
ZN-44375	White	2.2-4m	Max 30m	360°	3-2000	1200W	H50 x W103 x D103mm

ALIA

Adjustable Motion Sensor



Corner or flush mounted



- Polycarbonate construction
- LED compatible
- Detection Distance: max 12m



IP44
Rated



PIR
Sensor



0.15kg

Code	Finish	Installation Height	Distance	Range	LUX	Max Rated Load	Dimensions
ZN-33615-BLK	Black	1.6 – 2.5m	max 12m	180°	3-2000 LUX (adjustable)	1200W Halogen 300W LED	H120 W78 Proj53mm
ZN-33615-WHT	White						

DION

Adjustable Motion Sensor



- Polycarbonate construction
- LED compatible
- Adjustable LUX and timer
- Manual override (8 hrs)
- Detection Distance: 5 - 12m
- Timer: 10 secs - 15min



Code	Finish	Installation Height	Distance	Range	LUX	Max Rated Load	Dimensions
ZN-33579-BLK	Black	1.6 - 2.5m	5 - 12m	180°	3-2000 LUX (adjustable)	1200W Halogen 300W LED	H51.5 W80 Proj119.5mm
ZN-33579-WHT	White						

DION

Motion Sensor



- Polycarbonate construction
- LED compatible
- Detection Distance: 5 - 12m
- Timer: 10 secs - 7min



Code	Finish	Installation Height	Distance	Range	LUX	Max Rated Load	Dimensions
ZN-25151-BLK	Black	1.6 - 2.5m	5 - 12m	180°	3-2000 LUX (adjustable)	1200W Halogen 300W LED	H150 W90 Proj120mm

ADRA

Photocell Sensor

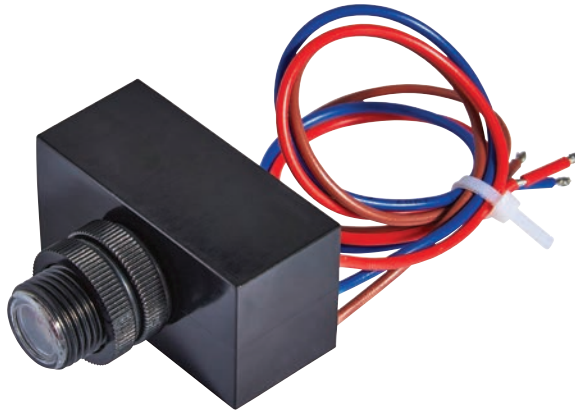

- Hideaway Sensor for use in Conduit/Whisker/Junction box
- Rated current: 10A
- Ambient light: <10LUX

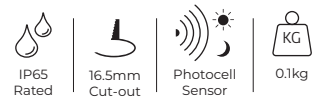

Code	Finish	Max Rated Load	Dimensions
ZN-38599-BLK	Black	1200W Halogen 300W LED	H70 W110 Proj35mm

DION

Batten Motion Sensor



- Add to an LED batten to enable an occupancy function
- Polycarbonate construction
- LED compatible
- Detection Distance: max 10m
- Detection Range: 360°
- Timer: 10 secs - 30min



Code	Finish	Installation Height	Distance	Range	LUX	Max Rated Load	Dimensions
ZN-38600-WHT	White	1.6 – 2.5m	max 10m	360°	3-2000 LUX (adjustable)	1200W Halogen 300W LED	H28 W33 Proj113mm

LOCA

Advanced Motion Sensor



- LED compatible
- 3 integral sensors
- 20m max detection distance
- 360° detection range
- 10 secs – 30 mins adjustable timer
- Polycarbonate construction



Code	Installation Height	Distance	Range	LUX	Max Rated Load	Dimensions
ZN-29177-WHT	2.2-6m	Max 20m	360°	3-2000 LUX (adjustable)	1200W Halogen 500W LED	L:102 W:102 H:58mm

LOCA

Motion Sensor



- LED compatible
- 3 integral sensors
- 12m max detection distance
- 360° detection range
- 10 secs – 7 mins adjustable timer
- Polycarbonate construction



Code	Installation Height	Distance	Range	LUX	Max Rated Load	Dimensions
ZN-25154-WHT	2.2-4m	12m max	360°	3-2000 LUX (adjustable)	1200W Halogen 300W LED	H:55mm Dia:88mm

LOCA

Motion Sensor



- LED compatible
- 6m max detection distance
- 360° detection range
- 10 secs – 15 mins adjustable timer
- Polycarbonate construction

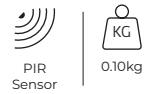

Code	Installation Height	Distance	Range	LUX	Max Rated Load	Dimensions
ZN-25153-WHT	2.2-4m	Max 6m	360°	3-2000 LUX (adjustable)	1200W Halogen 300W LED	H46 Dia:88mm

LOCA

Recessed Motion Sensor



- Easily remove cover when recessed to adjust settings
- LED compatible
- 8m max detection distance
- 360° detection range
- 10 secs – 15 mins adjustable timer
- Polycarbonate construction



Code	Installation Height	Distance	Range	LUX	Max Rated Load	Dimensions
ZN-25155-WHT	2.2-4m	Max 8m	360°	3-2000 LUX (adjustable)	1200W Halogen 200W LED	H16.8 Dia:50mm

ALIA

CORNER MOTION SENSOR



AVAILABLE SETTINGS

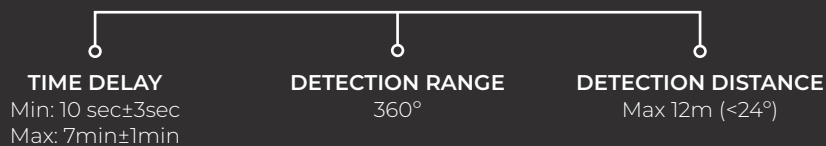

ALIA

Corner Motion Sensor



- Polycarbonate construction
- LED compatible
- Adjustable shield to focussed detection
- Can be fitted to an external or internal corner.
- Mount can be removed to fit flush against walls.
- Detection Distance: 5 - 12m
- Detection Range: 360°
- Timer: 10 secs - 7min

Removeable corner mount



Code	Finish	Installation Height	Distance	Range	LUX	Max Rated Load	Dimensions
ZN-25152-BLK	Black	1.8-2.5m	5-12m	360°	3-2000 LUX (adjustable)	1200W Halogen	H79 W60 Proj119mm
ZN-25152-WHT	White					300W LED	

THEA

Conduit Motion Sensor



- 3 mounting positions
- LED compatible
- 8m max detection distance
- 360° detection range
- 10 secs – 30 mins adjustable timer
- Polycarbonate construction



78mm
Cut-out



PIR
Sensor



0.05kg

Code	Installation Height	Distance	Range	LUX	Max Rated Load	Dimensions
ZN-31805-WHT	2.2-4m	Max 8m	360°	3-2000 LUX (adjustable)	1200W Halogen 300W LED	H39 Dia:80mm

ADRA

Dusk Till Dawn Sensor



- LED compatible
- Adjustable LUX level
- 1, 2, 3, 4, 5, 6, 7, 8, 9 hours timer
- Polycarbonate construction



IP65
Rated



Photocell
Sensor



0.13kg

Code	Timer	LUX	Max Rated Load	Dimensions
ZN-25156-BLK	1, 2, 3, 4, 5, 6, 7, 8, 9 Hours	3-500 LUX (adjustable)	1200W Halogen 250W LED	H190 W70 Proj41mm

THEA

Wall/Ceiling Microwave Sensor



- Greater installation height
- Increased detection range
- Can sense movement through most building materials
- LED compatible
- 2 – 15m detection distance when wall mounted
- 1.8mm radius when ceiling mounted
- 180/360° detection range
- 10 secs – 12 mins adjustable timer



Microwave
Sensor



0.045kg

Code	Installation Height	Distance	Range	LUX	Max Rated Load	Dimensions
ZN-29185-WHT	1.6 – 3.5m	2 – 15m	180/360°	3-2000 LUX (adjustable)	1200W Halogen 300W LED	L:76 W:37 H:25mm

THEA

Stealth Microwave Sensor



- Greater installation height
- Increased detection range
- Can sense movement through most building materials
- LED compatible
- 1 – 8m detection distance
- 360° detection range
- 10 secs – 12 mins adjustable timer

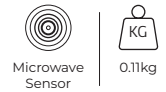

Code	Installation Height	Distance	Range	LUX	Max Rated Load	Dimensions
ZN-29186-WHT	1.6 – 3.5m	1 – 8m	360°	3-2000 LUX (adjustable)	1200W Halogen 500W LED	H24 Dia:115mm

THEA

Recessed Microwave Sensor



- Greater installation height
- Increased detection range
- Can sense movement through most building materials
- LED compatible
- 5 – 15m detection distance
- 360° detection range
- 10 secs – 12 mins adjustable timer



Code	Installation Height	Distance	Range	LUX	Max Rated Load	Dimensions
ZN-29187-WHT	1.6 – 3.5m	5 – 15m	360°	3-2000 LUX (adjustable)	1200W Halogen 300W LED	H75.4 Dia:76mm





ZINK

SOLAR

The Zink solar range offers a wide selection of solar powered, functional, aesthetic, domestic light fittings, that are easily installed where a mains supply is inaccessible.

POST/LANTERNS	118-122
GROUND LIGHTS	123
WALL LIGHTS	124-126
PIR WALL LIGHTS	127-131
SECURITY & FLOODLIGHTS	133
SPIKE LIGHTS	134-139
DECK LIGHTS	140
FESTOON LIGHTS	141



CADEBY

LED Solar Wall Lantern

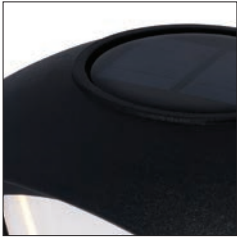

- ABS & Polycrystalline construction
- Integrated solar panel allows installation in areas with no mains power
- Energy saving solar powered LED light
- A full charge will last up to 8 hours
- IP44 weather resistant

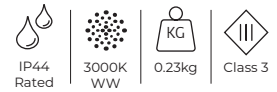

Code	Finish	Power (w)	Colour (k)	Lumen (lm)	Charge Time	Batteries	Dimensions
ZN-42031	Black	1W	3000k	15	6-8hrs	1 x 1.2V AA NiMH 900mAh	W:140 H:205 Proj:160mm

CADEBY

LED Solar Post Lantern

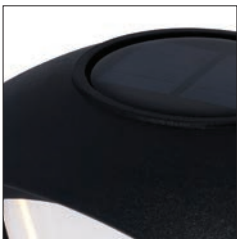

- ABS & Polycrystalline construction
- Integrated solar panel allows installation in areas with no mains power
- Energy saving solar powered LED light
- A full charge will last up to 8 hours
- IP44 weather resistant



Code	Finish	Power (w)	Colour (k)	Lumen (lm)	Charge Time	Batteries	Dimensions
ZN-42032	Black	1W	3000k	15	6-8hrs	1 x 1.2V AA NiMH 900mAh	H:575 Dia. 170mm



HORDEN

LED Solar Hanging Wall Lantern



- OFF/Low/High light function
- Iron, aluminium and glass construction
- Integrated solar panel allows installation in areas with no mains power
- Energy saving solar powered LED light
- A full charge will last up to 8 hours
- IP44 weather resistant



Code	Finish	Power (w)	Colour (k)	Lumen (lm)	Charge Time	Batteries	Dimensions
ZN-42033	Black	1W	3000k	15	6-8hrs	1 x 1.2V AA NiMH 1000mAh	W:175 H:380 Proj:225mm

TANFIELD

LED Solar Post Lantern



- OFF/Low/High function
- Iron, aluminium and glass construction
- Integrated solar panel allows installation in areas with no mains power
- Energy saving solar powered LED light
- A full charge will last up to 8 hours
- IP44 weather resistant



Code	Finish	Power (w)	Colour (k)	Lumen (lm)	Charge Time	Batteries	Dimensions
ZN-42034	Black	1W	3000k	200	6-8hrs	1 x 1.2V AA NiMH 900mAh	H:575 Dia. 170mm

CRESWELL

LED Solar Wall Light

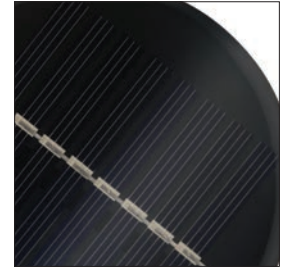

- Stainless steel (201) construction
- OFF/Low/High switch function
- Integrated solar panel allows installation in areas with no mains power
- Energy saving solar powered LED light
- A full charge will last up to 8 hours
- IP44 weather resistant



Code	Finish	Power (w)	Colour (k)	Lumen (lm)	Charge Time	Batteries	Dimensions
ZN-42043	SST	0.6W	6000k	30	6-8hrs	2 x 1.2V AA NiMH 900mAh	W:117 H:365 Proj:145mm

CRESWELL

LED Solar Spike Light



- Stainless steel (201) construction
- OFF/Low/High switch function
- Integrated solar panel allows installation in areas with no mains power
- Energy saving solar powered LED light
- A full charge will last up to 8 hours
- IP44 weather resistant



Code	Finish	Power (w)	Colour (k)	Lumen (lm)	Charge Time	Batteries	Dimensions
ZN-42044	SST	0.6W	6000k	30	6-8hrs	2 x 1.2V AA NiMH 900mAh	H:365 Dia. 117mm

TANFIELD

LED Solar Post/Ground Light

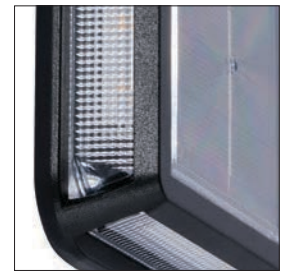

- Low level design for installation almost anywhere
- 121mm x 121mm design to fit on top of a fence post as well as a ground light
- Aluminium and PVC construction
- Integrated solar panel allows installation in areas with no mains power
- Energy saving solar powered LED light
- Built in photocell sensor for auto ON at dusk/dawn
- A full charge will last up to 8 hours
- IP65 weather resistant



Code	Finish	Power (w)	Colour (k)	Lumen (lm)	Charge Time	Batteries	Dimensions
ZN-42035	Black	1W	4000k	30	6-8hrs	1 x 1.2V AA NiMH 600mAh	L:121 W:121 Proj:29mm

WISTOW

LED Solar Wall Light



- Diecast Aluminium/Glass
- Solar panel can be charged with the mini USB-A cable
- Energy saving solar powered LED light
- A full charge will last up to 8 hours
- IP44 weather resistant



Code	Finish	Power (w)	Colour (k)	Lumen (lm)	Charge Time	Batteries	Dimensions
ZN-42039	Anthracite	0.4W	3000k	10	6-8hrs	1 x 1.2V AA NiMH 1000mAh	W:83 H:205 Proj:53mm

ELDON

LED Up/Down Solar Wall Light



125 | SOLAR

- Stainless steel (201) construction
- OFF/Dim 1/Dim 2/Dim 3 push button switch
- Separate solar panel with 5m cable allows installation in areas with no mains power
- Solar panel can be charge with the mini USB-A cable
- Energy saving solar powered LED light
- A full charge will last up to 8 hours
- IP44 weather resistant

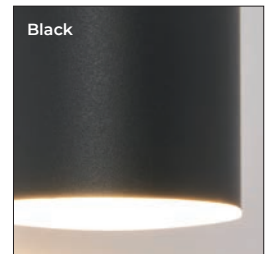

Code	Finish	Power (w)	Colour (k)	Lumen (lm)	Charge Time	Batteries	Dimensions
ZN-42040	SST	2W	3000k	150	6-8hrs	1 x 3.7V Li-ion 2000mAh	W:77 H:185Proj:110mm
ZN-42041	Anth						

TRIMDON

LED Solar Downlight

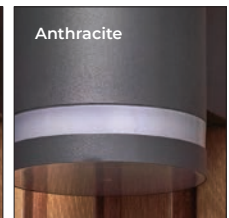
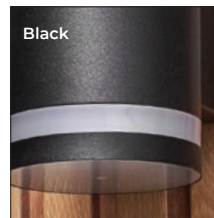

- Stainless steel (201) & PC construction
- OFF/Low/High switch function
- Integrated solar panel allows installation in areas with no mains power
- Energy saving solar powered LED light
- A full charge will last up to 8 hours
- IP44 weather resistant



Code	Finish	Power (w)	Colour (k)	Lumen (lm)	Charge Time	Batteries	Dimensions
ZN-42045	SST						
ZN-42046	Black	1W	3000k	100	6-8hrs	1 x 3.7V Li-ion 1200mAh	W:90 H:135 Proj:120mm
ZN-42047	Anth						

CLAIRE

LED Solar Wall Light with PIR Sensor

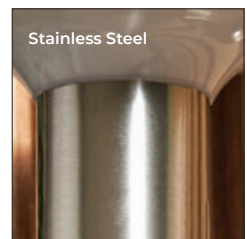

- 3 Modes: a) Always ON 60lm b) Always ON 60lm, Motion Detected 240lm 25secs c) Always OFF, Motion Detection Detected 600lm 25secs d) OFF
- Stainless steel (201) & PC construction
- Integrated solar panel allows installation in areas with no mains power
- Energy saving solar powered LED light
- 8-12m detection distance
- A full charge will last up to 8 hours
- IP44 weather resistant



Code	Finish	Power (w)	Colour (k)	Lumen (lm)	Charge Time	Batteries	Dimensions
ZN-42048	SST	5.6W	3000k	600	6-8hrs	1 x 3.7V Li-ion 2200mAh	W:160 H:180 Proj:162mm
ZN-42049	Black						

SOLAR

Security Sensor Light with PIR Sensor

200
LUMENS



IP44

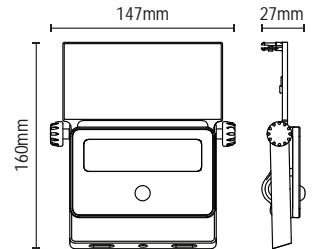

- Glass lens with ABS and steel construction
- Battery: 1800mAh Li-ion
- Time on: 30 seconds
- 3-5m Detection Distance
- 2W LED module (SMD)
- K: 6000
- Lm: 200
- Lm/W: 100
- Hrs: 20,000



IP44
Rated



6000K
DW



PIR
Sensor

Code	Finish	Power (w)	Colour (k)	Total Flux (lm)	Efficiency (lm/W)	Dimensions
ZN-37052-BLK	Black	2W	6000k	200	100	H:160 W:147 Proj:134mm

MARLEY

LED Solar Wall Light with PIR Sensor



- OFF/High/Low push button function
- ABS construction
- Integrated solar panel allows installation in areas with no mains power
- Energy saving solar powered LED light
- PIR sensor turns light on for 15 seconds after sensing movement with 3-5m detection distance
- A full charge will last up to 8 hours
- IP44 weather resistant

Code	Finish	Power (w)	Colour (k)	Lumen (lm)	Charge Time	Batteries	Dimensions
ZN-42037	Black	4W	6000k	230 (hi) 100 (low)	6-8hrs	1 x 3.7V Li-ion 1500mAh	H:125 W:95 Proj:49mm

DAWDON

LED Solar Wall Light with PIR Sensor



- OFF/High/Low push button function
- ABS & PC construction
- Integrated solar panel allows installation in areas with no mains power
- Energy saving solar powered LED light
- PIR sensor turns light on for 25 seconds after sensing movement with 3-5m detection distance
- A full charge will last up to 8 hours
- IP44 weather resistant



Code	Finish	Power (w)	Colour (k)	Lumen (lm)	Charge Time	Batteries	Dimensions
ZN-42042	Black	9.2W	6000k	450	6-8hrs	2 x 3.7V Li-ion 2000mAh	H:115 W:207 Proj:85mm

BLACKHALL

LED Solar Wall Light with Microwave Sensor



- Battery > 30% AUTO ON 20lm at Dusk/Dawn, 230/300lm when motion detected by microwave sensor 15secs < 30% OFF Dusk/Dawn, 230/300lm when motion detected by microwave sensor 15secs
- ABS construction
- Integrated solar panel allows installation in areas with no mains power
- Energy saving solar powered LED light
- Microwave and photocell sensor
- A full charge will last up to 8 hours
- IP44 weather resistant



Code	Power (w)	Colour (k)	Lumen (lm)	Charge Time	Batteries	Dimensions	Weight (kg)
ZN-42054	2.5W	6500k	230	4-6hrs	1x 3.7V Li-ion 1500mAh	H:190 W:95 Proj:90mm	0.22kg
ZN-42055	3.5W	6500k	300		1x 3.7V Li-ion 1800mAh	H:225 W:115m Proj:105mm	0.28kg



IP65

ZIPK

DENBY

LED Solar Floodlight



- Remote control operated with adjustable functions. ON/OFF, Brightness \pm , Timer 3, 5 or 8 Hours, Automatic.
- Aluminium, glass & steel construction
- Separate solar panel with 1m cable allows installation in areas with no mains power
- Energy saving solar powered LED light
- Charge lasts up to 12 hours after full charge
- IP65 weather resistant
- Available in 3 sizes and wattages



Code	Power (w)	Colour (k)	Lumen (lm)	Working Time	Batteries	Dimensions	Weight (kg)
ZN-42051	1.5W	6500k	300	12hrs	1 x 3.7V LiPo 2500mAh	W:150 H:170 Proj:113mm	1.076kg
ZN-42052	2.5W	6500k	450	12hrs	2 x 3.7V LiPo 5000mAh	W:182 H:203 Proj:135mm	1.6kg
ZN-42053	6W	6500k	1000	12hrs	2 x 3.2V LiPo 1000mAh	W:195 H:230 Proj:155mm	2.1kg



BYERMOOR

LED Solar Smart Spike Light



- Charge lasts up to 6 hours on high, 12 hours on low brightness after full charge
- Compatible with Smart Apps
- ABS & PC construction
- Integrated solar panel allows installation in areas with no mains power
- Energy saving solar powered LED light
- IP65 weather resistant



Code	Finish	Power (w)	Colour (k)	Lumen (lm)	Charge Time	Batteries	Dimensions
ZN-42050	Black	1W	RGB+W CCT	50	6hrs	1 x 5.5V Li-ion 1200mAh	H:420 W:107 D:145mm



BRADLEY

LED Solar Floodlight with Ground Spike



- 4 Modes: a) Always ON 90lm b) Always ON 90lm, Motion Detected 500lm 30secs c) Always OFF, Motion Detection Detected 500lm 30secs d) SOS
- ABS & PC construction
- Supplied with IR remote control
- Integrated solar panel allows installation in areas with no mains power
- Energy saving solar powered LED light
- 4-6m detection distance
- A full charge will last up to 8 hours
- IP54 weather resistant

Code	Finish	Power (w)	Colour (k)	Lumen (lm)	Charge Time	Batteries	Dimensions
ZN-42057	Black	3W	6500k	500	8-9hrs	1 x 3.7V Li-ion 1200mAh	H:610 W:345 Proj:130mm

DAW

LED Solar Spike Light Kit

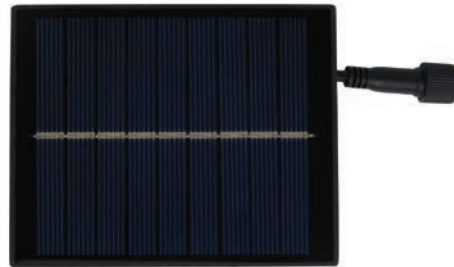

- Supplied with IR remote control
- ABS & PC construction
- Solar panel has 4m cable until first lamp then 2m spacing between each lamp
- Energy saving solar powered LED light
- Lamps can be spike or deck mounted
- IP65 weather resistant



Code	Finish	Power (w)	Colour (k)	Lumen (lm)	Charge Time	Batteries	Dimensions
ZN-42059	Black	2W	RGB+ 4000K	200	8-10hrs	2 x 3.7V Li-ion 2400mAh	H:230 Dia. 37 (per lamp)

MALTBY

LED Solar Spike Light Kit



- Supplied with IR remote control
- ABS & Glass construction
- Solar panel has 4m cable until first lamp then 2m spacing between each lamp
- Energy saving solar powered LED light
- Lamps can be spike or deck mounted
- IP65 weather resistant



Code	Finish	Power (w)	Colour (k)	Lumen (lm)	Charge Time	Batteries	Dimensions
ZN-42058	Black	2W	RGB+ 4000K	200	8-10hrs	2 x 3.7V Li-ion 2400mAh	H:250 Dia. 40 (per lamp)

AYLE

LED Solar Deck Light Kit



14 | SOLAR



- Supplied with IR remote control
- Stainless steel (201), ABS & Glass construction
- Solar panel has 4m cable until first lamp then 2m spacing between each lamp
- Energy saving solar powered LED light
- Solar panel can be spike or deck mounted
- IP65 weather resistant



Code	Finish	Power (w)	Colour (k)	Lumen (lm)	Charge Time	Batteries	Dimensions
ZN-42060	Black	2W	RGB+ 4000K	200	8-10hrs	2 x 3.7V Li-ion 2400mAh	H:47 Dia. 41.5 (per lamp)

WYE

LED Solar Festoon Light Kit



- 4 Light Modes: ON/Slow Flash/Fast Flash/Pulsating
- Solar panel can be wall or spike mounted and recharged with the USB-A cable supplied
- Solar panel has 4m cable until first lamp then 0.6m spacing between each lamp
- Energy saving solar powered LED light
- A full charge will last up to 8 hours
- IP44 weather resistant



Code	Finish	Power (w)	Colour (k)	Lumen (lm)	Charge Time	Batteries	Dimensions
ZN-42229	Black	5W	2700	60 (each)	8-10hrs	1 x 3.7V Li-ion 2200mAh	Overall L:1000mm



PREMIUM OUTDOOR

An extensive range of corrosion resistant outdoor lighting constructed from polycarbonate with grade 316 stainless steel fixings. Designed to withstand the most extreme environments.

POST LIGHTS	144-145
LANTERNS	146-152
BULKHEADS	153-157
WALL LIGHTS	158-164
GUIDE LIGHTS	165-167
GROUND/SPIKE LIGHTS	168
SECURITY & FLOODLIGHTS	169

BIANCA

Post Lantern

ADJUSTABLE
HEIGHT

IP44

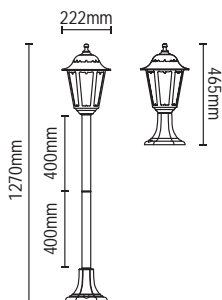

- Polycarbonate construction
- Corrosion resistant
- Three height options:
1260mm/860mm/460mm



IP44
Rated



Class 2

Code

Lamp

Dimensions

CZ-25148-BLK

1 x 10W max
LED E27 GLS

W:222 H:1270mm



BIANCA

Triple Head Tall Post Lantern

IP44

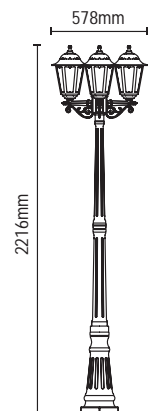

- Polycarbonate construction
- Corrosion resistant



Code	Lamp	Dimensions
CZ-25149-BLK	3 x 10W max LED E27 GLS	Dia: 578 H:2216mm

BIANCA

Up or Down Wall Lantern

ADJUSTABLE
HEIGHT

IP44

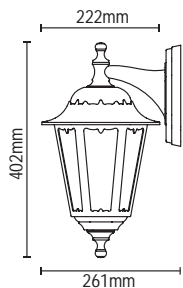

- Polycarbonate construction
- Corrosion resistant
- 2 alternate installation options



IP44
Rated



Class 2



0.73kg

Code

CZ-25145-BLK

Lamp

1 x 10W max LED E27 GLS

Dimensions

Proj:261 W:222 H:402mm

BIANCA

Wall Lantern with PIR



MANUAL
OVERRIDE

IP44

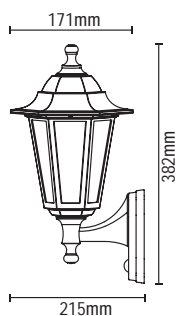

- Polycarbonate construction
- Corrosion resistant
- 6m Detection Distance
- Manual override function enables you to switch off PIR



IP44
Rated



PIR
Sensor



Class 2



0.84kg

Code

CZ-25150-BLK

Lamp

1 x 10W max LED E27 GLS

Dimensions

Proj:215 W:171 H:382

ATHENA

Half Wall Lantern

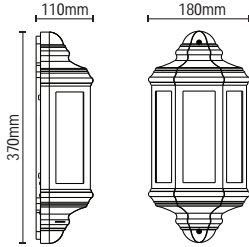

- Polycarbonate construction
- Corrosion resistant
- Vintage style half lantern
- Available with or without PIR sensor
- 6m Detection Distance



Code	Sensor	Lamp	Dimensions
CZ-31748-BLK	-	1 x 10W max LED E27 GLS	Proj:110 W:180 H:370mm
CZ-26743-BLK	PIR		

JURA

Wall Lantern

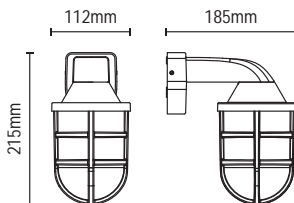

- ABS & PC construction
- Corrosion resistant



Code	Lamp	Dimensions
CZ-35742-BLK	1 x 10W LED Max E27 GLS	Proj:185 W:112 H:215mm



PILULE

Wall Light

IP54



Alternative mounting option

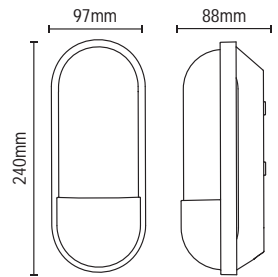

- Polycarbonate construction
- Corrosion resistant
- Available in black & anthracite
- Can be fitted either upward, downward or sideways



Code	Finish	Lamp	Dimensions
CZ-38639-BLK	Black	1 x 10W max LED E27 GLS	W:97 H:240 Proj:88mm
CZ-38639-ANTH	Anthracite		

YORK

Globe Wall Lantern

IP44

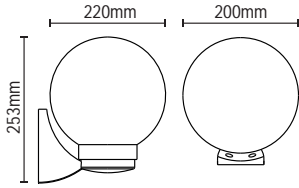

- Polycarbonate construction
- Corrosion resistant



Code	Lamp	Dimensions
CZ-31811-BLK	1 x 10W max LED E27 GLS	Proj:220 W:200 H:253mm

YORK

Globe Post Lantern

IP44

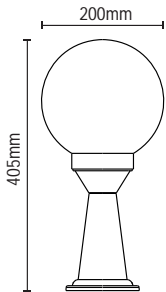

- Polycarbonate construction
- Corrosion resistant



Code	Lamp	Dimensions
CZ-31812-BLK	1 x 10W max LED E27 GLS	Dia:220mm H:405mm

YORK

Globe Porch Lantern

IP44

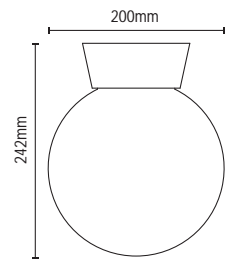

- Polycarbonate construction
- Corrosion resistant
- Contemporary styling
- Vandal resistant materials



Code	Lamp	Dimensions
CZ-33461-BLK	1 x 10W max LED E27 GLS	Dia:200 H:242mm

BATSU

LED Curved Wall Light

IP65

NEW



Code	Finish	PIR	Power (w)	Colour (k)	Total Flux (lm)	Dimensions
CZ-44225-BLK	Black	-	12W	4000k	1200	H220 x W80 x D190mm
CZ-44226-BLK	Black	Yes				

MARS

Round Bulkhead

IP44

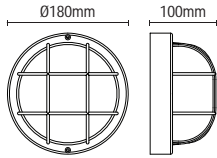

- Durable polycarbonate construction with glass cover
- Corrosion resistant
- Protective grille



Code	Lamp	Dimensions
CZ-20947-BLK	1 x 10W max LED E27 GLS	Proj:100 Dia:180mm

PUCK

Oval Eyelid Bulkhead

IP44

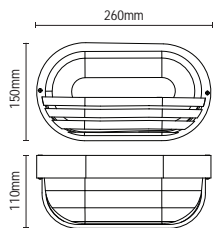

- Durable polycarbonate construction with glass cover
- Corrosion resistant
- Protective grille



Code	Lamp	Dimensions
CZ-25142-BLK	1 x 10W max LED E27 GLS	Proj:110 W:260 H:150mm

CANO

LED Round Bulkhead



Upto
750
Lumens

IP54



- Black PC / Opal diffuser
- Corrosion resistant
- Wall or ceiling mounted
- 6m Detection Distance
- 8W LED module (SMD)
- K: 4000
- Lm: 400
- Lm/W: 50
- Hrs: 25,000



Code	Size	Power (w)	Colour (k)	Total Flux (lm)	Efficiency (lm/W)	Dimensions
CZ-33397-BLK	Small	8W	4000k	400	50	Proj:57 Dia:155mm

TURUS

LED Round Bulkhead

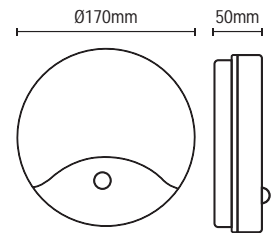

- Black PC / Opal diffuser
- Corrosion resistant
- Colour changing technology
- Switch between 3000K/4000K/6000K
- Available with or without PIR sensor
- 6m Detection Distance
- 15W LED module (SMD)
- Push-fit connectors



Code	Sensor	Power (w)	Colour (k)	Total Flux (lm)	Efficiency (lm/W)	Dimensions
CZ-34014-BLK	-	15W	CCT	1200	80	Proj:50 Dia:170mm
CZ-34015-BLK	PIR	15W	CCT	840	56	Proj:50 Dia:170mm

TURUS

LED Oval Bulkhead

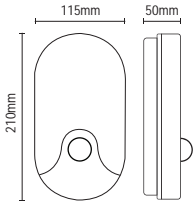

- Black PC / Opal diffuser
- Corrosion resistant
- Colour changing technology
- Switch between 3000K/4000K/6000K
- Available with or without PIR sensor
- 6m Detection Distance
- 15W LED module (SMD)
- Lm/W: 50
- Hrs: 25,000
- Push-fit connectors



Code	Sensor	Power (w)	Colour (k)	Total Flux (lm)	Efficiency (lm/W)	Dimensions
CZ-34016-BLK	-	15W	CCT	1200	80	H:210 W:115 Proj:50mm
CZ-34017-BLK	PIR	15W	CCT	840	56	H:210 W:115 Proj:50mm

OXFORD

Round LED Bulkhead

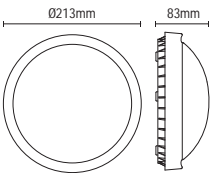

- Polycarbonate and ABS construction
- Corrosion resistant
- Can be wall or ceiling mounted
- 8W LED module (SMD)
- Lm/W: 73
- Hrs: 20,000



Code	Power (w)	Colour (k)	Total Flux (lm)	Efficiency (lm/W)	Dimensions
CZ-31750-BLK	8W	4000k	590	73	Proj:83 Dia:213mm

RIPON

LED Bulkhead

Upto
1245
Lumens

IP65

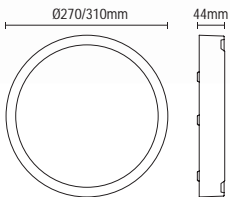

- Polycarbonate construction
- Corrosion resistant
- Can be wall or ceiling mounted

CZ-31745-BLK

- 15W LED module (SMD)
- Lm/W: 60
- Hrs: 20,000

CZ-31743-BLK

- 18W LED module (SMD)
- Lm/W: 70
- Hrs: 20,000



Code	Size	Power (w)	Colour (k)	Total Flux (lm)	Efficiency (lm/W)	Dimensions
CZ-31745-BLK	Small	15W	4000k	900	60	Proj:44 Dia:270mm
CZ-31743-BLK	Large	18W	4000k	1245	70	Proj:44 Dia:310mm

LUTON

LED Wedge

648
Lumens

IP65

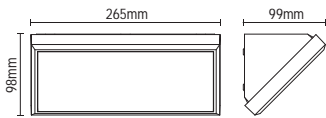

- Polycarbonate and ABS construction
- Corrosion resistant
- 12W LED module (SMD)
- Lm/W: 64
- Hrs: 20,000



Code	Power (w)	Colour (k)	Total Flux (lm)	Efficiency (lm/W)	Dimensions
CZ-31746-BLK	12W	4000k	648	64	Proj:99 W:265 H:98mm

DERBY

LED Wedge with Hi-Lo Dimmer



1260
Lumens

IP65

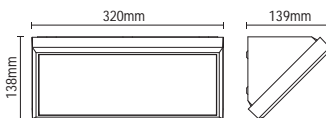

- Corrosion resistant PC & ABS construction
- Adjustable sensitivity, hold time, lux level, standby time & standby dim level.
- Microwave & daylight Sensor



Code	Power (w)	Colour (k)	Total Flux (lm)	Efficiency (lm/W)	Dimensions
CZ-31740-BLK	21W	4000k	1260	60	Proj:139 W:320 H:138mm

IONA

Downlight

IP44

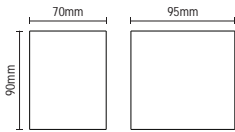

- ABS construction
- Corrosion resistant

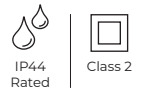

Code	Lamp	Dimensions
CZ-35704-BLK	1 x 5W Max LED GU10	Proj:90 W:70 H:95mm

IONA

Up/Down Wall Light

IP44

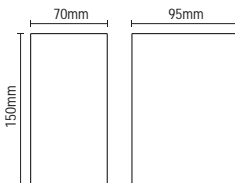

- ABS construction
- Corrosion resistant



Code	Lamp	Dimensions
CZ-35705-BLK	2 x 5W Max LED GU10	Proj:95 W:70 H:150mm

ARBO

Carbon Fibre Down Wall Light

IP44

NEW



IP44
Rated

0.17kg

· 1 x Gu10 7W max

Code	Finish	Lamp	Dimensions
CZ-37501-ANTH	Anthracite	1x Gu10 7W max	H160 x W75 x D110mm
CZ-37501-RUST	Rust		

ARBO

Carbon Fibre Up/Down Wall Light

IP44

NEW



IP44
Rated

0.26kg

· 2 x Gu10 7W max

Code	Finish	Lamp	Dimensions
CZ-37502-ANTH	Anthracite	2 x Gu10 7W max	H160 x W75 x D110mm
CZ-37502-RUST	Rust		

ARBO

Carbon Fibre Up/Down Wall Light with PIR

IP44

NEW



IP44
Rated

0.37kg

· 2 x Gu10 7W max

Code	Finish	Lamp	Dimensions
CZ-37503-ANTH	Anthracite	2 x Gu10 7W max	H210 x W70 x D120mm
CZ-37503-RUST	Rust		

NESO

Up/Down Wall Light with PIR

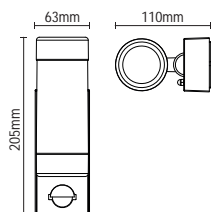

- Polycarbonate construction
- Corrosion resistant
- PIR sensor
- 6m Detection Distance



Code

Lamp

Dimensions

CZ-31744-BLK

2 x 7W Max LED GU10

Proj:110 W:63 H:205mm

NESO

Up/Down Wall Light

IP65

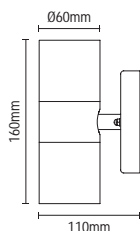

- Polycarbonate construction
- Corrosion resistant



Code

Lamp

Dimensions

CZ-25144-BLK-65

2 x 7W Max LED GU10

Proj:110 W:81 H:160mm

NESO

Downlight

IP65

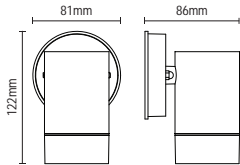

- Polycarbonate construction
- Corrosion resistant



Code	Lamp	Dimensions
CZ-25143-BLK-65	1 x 7W Max LED GU10	Proj:86 W:81 H:122mm

ISLAY

Up/Down Wall Light

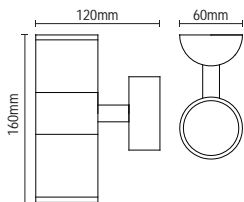

- Marine grade stainless steel (316) construction
- Corrosion resistant

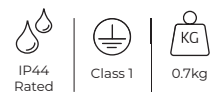

Code	Finish	Lamp	Dimensions
CZ-29320-SST	Stainless Steel	2 x 7W max LED GU10	H:160 W:70 Proj:120mm
CZ-29320-BLK	Black		
CZ-29320-ANTH	Anthracite		

ISLAY

PIR Up/Down Wall Light

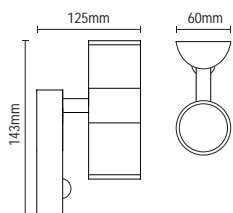

- Marine grade stainless steel (316) construction
- Corrosion resistant
- PIR sensor
- Adjustable lux and timer
- Detection Angle: 90°
- Detection Distance: 7m



Code	Finish	Lamp	Dimensions
CZ-29319-SST	Stainless Steel	2 x 7W max LED GU10	H:143 W:60 Proj:125mm
CZ-29319-BLK	Black		
CZ-29319-ANTH	Anthracite		

ISLAY

Spotlight

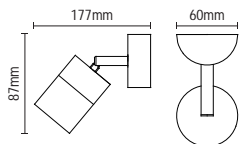
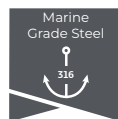

- Marine grade stainless steel (316) construction
- Corrosion resistant



Code	Finish	Lamp	Dimensions
CZ-29321-SST	Stainless Steel	1 x 7W max LED GU10	H:87 W:60 Proj:177mm
CZ-29321-BLK	Black		
CZ-29321-ANTH	Anthracite		

BREEZ

Surface Brick/Guide Light

648
Lumens

IP65

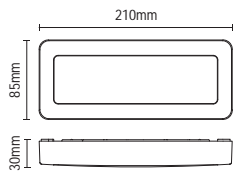

- Polycarbonate construction
- Anthracite finish
- Corrosion resistant
- 3W LED module (SMD)
- Lm/W: 93
- Hrs: 20,000



Code	Power (w)	Colour (k)	Total Flux (lm)	Efficiency (lm/W)	Dimensions
CZ-29191-ATR	3W	4000k	290	93	Proj:30 W:210 H:85mm



BREEZ

Surface Brick/Guide Light

280 Lumens IP65

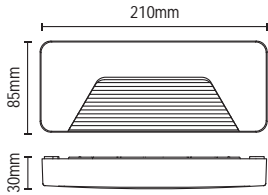

- Polycarbonate construction
- Anthracite finish
- Corrosion resistant
- 3W LED module (SMD)
- Lm/W: 93
- Hrs: 20,000

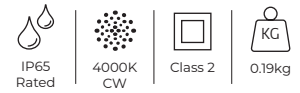

Code	Power (w)	Colour (k)	Total Flux (lm)	Efficiency (lm/W)	Dimensions
CZ-29192-ATR	3W	4000k	290	93	Proj:30 W:210 H:85mm

BREEZ

Surface Brick/Guide Light

180 Lumens IP65

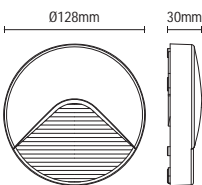

- Polycarbonate construction
- Anthracite finish
- Corrosion resistant
- 2W LED module (SMD)
- Lm/W: 90
- Hrs: 20,000

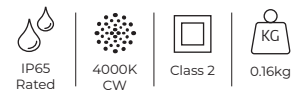

Code	Power (w)	Colour (k)	Total Flux (lm)	Efficiency (lm/W)	Dimensions
CZ-29193-ATR	2W	4000k	180	90	Proj:30 Dia:128mm

WELLS

Dual Mount Ground/Spike Light

IP44

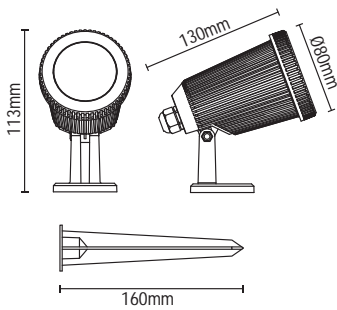

- Polycarbonate construction
- Corrosion resistant
- Detachable ground spike



Code

CZ-31806-BLK

Lamp

1 x 6W Max LED GU10

Dimensions

Proj:130 Dia:80 H:273mm

POOLE

LED Wall Downlight

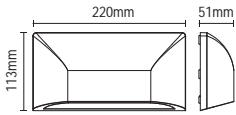

- Polycarbonate construction
- Black finish with opal diffuser
- Corrosion resistant
- PIR sensor (option)
- 6m detection range
- 12.5W LED module (SMD)
- Lm/W: 47
- Hrs: 20,000



Code	Power (w)	Colour (k)	Total Flux (lm)	Efficiency (lm/W)	Dimensions
CZ-31752-BLK	6W	4000k	300	50	Proj:51 W:220 H:113mm
CZ-31747-BLK	6.5W	4000k	300	46	Proj:51 W:220 H:113mm

ALAN

LED Adjustable Floodlight



- 180° flood



Code	Power (w)	Colour (k)	Total Flux (lm)	Efficiency (lm/W)	Dimensions
CZ-44370-BLK	2 x 10W	4000K	2026	103	H168 x W315 x D89mm



Spa

BATHROOM

A beautiful range of decorative lighting and mirrors, designed to brighten any bathroom.

RECESSED/DOWNLIGHTS	172-175
CEILING/WALL LIGHTS	176-195
SPOTLIGHTS	196-201
FLUSH	202-208
WALL LIGHTS	209-214
BATHROOM MIRRORS	215-229
BATHROOM CABINETS	230-231

EDEN

IP65 Tiltable Fire-rated Downlight



- Dimmable
- Fire rated
- Fast fit terminals
- 7W LED module (COB)
- 3000/4000/6000K (CCT)

- Lm: 700
- Lm/W: 100
- CRI: 80
- Hrs: 50,000

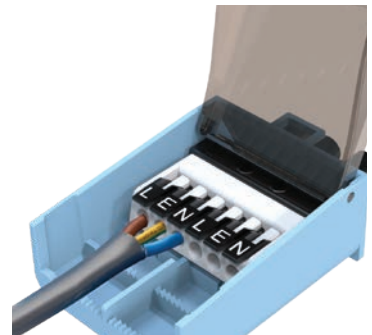

- Selectable colour temp
- Quick connect
- Push fit connector block



Code	Pack Size	Finish	Power (W)	Total Flux (lm)	Efficiency (lm/W)	Colour (k)	Dimensions
SPA-41111-WHT		White					
SPA-41111-BLK		Black					
SPA-41111-CHR	Single	Chrome	7W	700	100	3 CCT	Dia:87mm H:30mm
SPA-41111-SBRS		Satin Brass					Cutout:70mm
SPA-41111-SNIC		Satin Nickel					

RHOM

IP65 Fixed Fire-rated Downlight



- Dimmable
- Fire rated
- Colour changing technology
- Switch between 3000K/4000K/6000K
- Fast fit terminals
- Available in 7 finishes
- 8W LED module (SMD)
- Lm: 900
- Lm/W: 112.5
- CRI: 80
- Hrs: 50,000



Fire-rated



IP65 Rated



60° Beam



70mm Cut-out



CCT



Class 2



0.15kg

Code	Pack Size	Finish	Power (W)	Total Flux (lm)	Efficiency (lm/W)	Colour (k)	Dimensions
SPA-38572-ACOP		Antique Copper					
SPA-38572-BCHR		Black Chrome					
SPA-38572-CHR		Chrome					
SPA-38572-MWHT	Single	Matt White	8W	900	112.5	CCT	Dia:87mm H:65mm
SPA-38572-SBLK		Satin Black					Cutout:70mm
SPA-38572-SBRS		Satin Brass					
SPA-38572-SNIC		Satin nickel					

JENN

Anti-glare Fire-rated Downlight

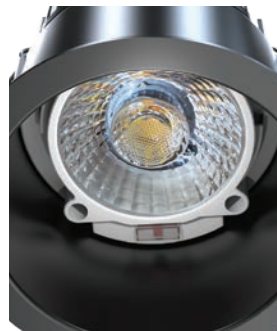

- Dimmable
- Fire rated
- Colour changing technology
- Switch between 2700K 3000K/4000K/6000K
- Fast fit terminals
- 8W LED module (COB)
- Lm: 900
- Lm/W: 112.5
- CRI: 80
- Hrs: 50,000
- Anti-glare reflector



Code	Finish	Power (W)	Total Flux (lm)	Efficiency (lm/W)	Colour (k)	Dimensions
SPA-41112-BLK/WHT	Black/White	8W	900	112.5	4 CCT	Dia:84mm H:65mm Cutout:70mm

COMO

IP65 Tiltable Fire-rated Downlight

FAST
FIT

700
Lumens

IP65



- Dimmable
- Fire rated
- 30mm Super low profile
- Fast fit terminals
- Available in 5 finishes
- 5W LED module (SMD)
- K: 4000
- Lm: 500
- Lm/W: 100
- CRI: 80
- Hrs: 50,000



Code	Finish	Power (W)	Total Flux (lm)	Efficiency (lm/W)	Colour (k)	Dimensions
SPA-38571-ACOP	Antique Copper	5W	500	100	4000	Dia:87mm H:30mm Cutout:70mm
SPA-38571-CHR	Chrome					
SPA-38571-MWHT	Matt White					
SPA-38571-SBLK	Satin Black					
SPA-38571-SBRS	Satin Brass					

TULIP

Glass Pendant/Semi-Flush

IP44



- Stainless steel and glass construction
- Available in 3 finishes
- Ceiling cup fits into recess at top of shade to enable fitting to be used as a semi-flush



Code	Finish	Lamp	Dimensions
SPA-41223-CHR	Chrome	1 x 10W max LED E27 GLS	Max Height: 1295mm Min Height: 295mm
SPA-41224-SBRS	Satin Brass		Dia:205mm
SPA-41225-SBLK	Satin Black		

OPIE

LED Glass Dome Flush

900
LUMENS

IP44



- Steel construction with opal glass shade
- Available in 3 finishes
- 12W LED module (SMD)
- Lm/W: 75
- CRI: 80



Dimmable



IP44
Rated



4000K
CW



Class 1



1.3kg

Code	Finish	Power (w)	Colour (k)	Total Flux (lm)	Dimensions
SPA-41694-MBLK	Matt Black				
SPA-41694-CHR	Chrome	12W	4000k	900	H:110 Dia:300mm
SPA-41694-SNIC	Satin Nickel				



NAYRU

LED Wall Light



SPA-44381-MBLK

SPA-44379-CHR



Class 1



IP44
Rated

Code	Finish	Power (w)	Lumens	Dimensions
SPA-44379-CHR	Chrome			
SPA-44380-SBRS	Satin Brass	8W	3000/4000K	H300 x W115 x D165mm
SPA-44381-MBLK	Black			

CUCO

Wall Light



Class 1



IP44
Rated

Code	Finish	Lamp	Dimensions
SPA-44384-CHR	Chrome/Opal		
SPA-44385-MBLK	Black/Opal	3W max LED G9	H295 x W70 x D50mm

LILLE

Bathroom Ceiling and Wall Light

IP44

NEW



SPA-35812-BLK



Class 1

IP44
Rated

Code	Finish	Description	Lamp	Dimensions
SPA-35812-BLK	Black/Satin Brass/Opal	2 Lights	3W max LED G9	H270 x W380 x D175
SPA-35814-BLK	Black/Satin Brass/Opal	3 Lights		H275mm x W290 x D290

ARLES

Bathroom Wall Light

IP44

NEW



SPA-39778-BLK



Class 1

IP44
Rated

Code	Finish	Lamp	Dimensions
SPA-39777-BLK	Black/Satin Brass/Opal	3W max LED G9	H420 x W140 x D120mm
SPA-39778-BLK	Black/Satin Brass/Clear		H270 x W195 x D150mm

PATRAS

1 Light Wall Light

IP44

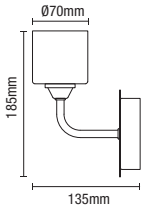

- Available in satin brass/champagne glass or chrome/smoked glass



Code	Finish	Lamp	Dimensions
SPA-35811-CHAMP	Satin Brass/Champagne	1 x 3W max LED G9	H:185 W:110 Proj:135mm
SPA-35811-CHR	Chrome/Smoke		

LINDOS

3 Light Ceiling Light

IP44

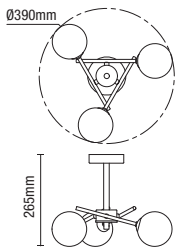

Code	Finish	Lamp	Dimensions
SPA-35836-SBRS	Satin Brass/Opal	3 x 3W max LED G9	H:265 Dia:390mm

EDESSA

LED Wall Light

500
LUMENS

IP44

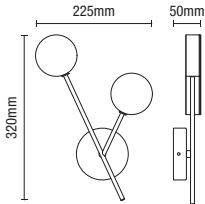

· Matching ceiling lights available

IP44
Rated

4000K
CW

Class 1

0.5kg

Code	Finish	Power (w)	Colour (k)	Total Flux (lm)	Dimensions
SPA-36309-CHR	Chrome	10W	4000k	500	H:320 W:225 Proj:50mm

EDESSA

LED Ceiling Light

1200
LUMENS

IP44

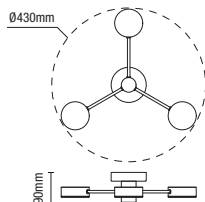

· Matching wall light available

IP44
Rated

4000K
CW



Class 1

Code	Finish	Power (w)	Colour (k)	Total Flux (lm)	Dimensions	Weight
SPA-36310-CHR	Chrome	15W	4000k	800	H:90 Dia:430mm	0.7kg

THIVA

Bathroom Wall Light

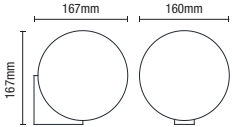
IP44



- Contemporary bathroom wall light
- Available in 3 finishes



Code	Finish	Lamp	Dimensions
SPA-38576-TBLK	Textured Black	1 x 3W max LED G9	H:167 W:160 Proj:167mm
SPA-38576-CHR	Chrome		
SPA-38576-SBRS	Satin Brass		

CHIOS

LED Ceiling Light

900
LUMENS

IP44

NEW
COLOUR

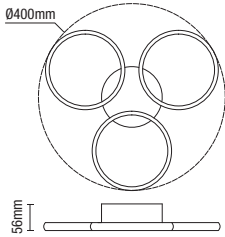

- 26W LED module (SMD)
- Lm/W: 34
- CRI: 80



Code	Finish	Power (w)	Colour (k)	Total Flux (lm)	Dimensions
SPA-36129-CHR	Chrome	26W	4000k	900	H:56 Dia:400mm
SPA-36129-MBLK	Matt Black				

SPARTI

Wall Light

IP44

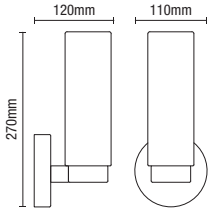

Code	Finish	Lamp	Dimensions
SPA-35843-SBRS	Satin Brass	1 x 3W max LED G9	H:270 W:110 Proj:120mm

DAFNI

LED Flush

IP44

NEW



Code	Finish	Colour (k)	Power (w)	Total Flux (lm)	Dimensions
SPA-36130-MBLK	Matt Black	4000k	32W	2835	H210 x W845 x D240mm

MANDRA

LED Ceiling Light

400
LUMENS

IP44

NEW
COLOUR



- 11W LED module (SMD)
- Lm/W: 36
- CRI: 80



IP44
Rated



Non
Dimmable



4000K
CW



Class 2



0.6kg

Code	Finish	Power (w)	Colour (k)	Total Flux (lm)	Dimensions
SPA-36140-CHR	Chrome	11W	4000k	400	H:130 Dia:340mm
SPA-36140-MBLK	Matt Black				

ORLANDO

Flush

IP44



- Clear glass crystal droplets



Code	Finish	Lamp	Weight	Dimensions
SPA-24468-CHR	Chrome	4 x 3W max LED G9	2.36kg	L230 x W230 x H189mm

ORLANDO

Flush

IP44



- Clear glass crystal droplets



Code	Finish	Lamp	Dimensions
SPA-24869-CHR	Chrome	4 x 3W max LED G9	H260 x Dia230mm

PEGASI

Wall Light

IP44



SPA-33931-CHR

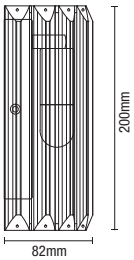

SPA-33932-CHR

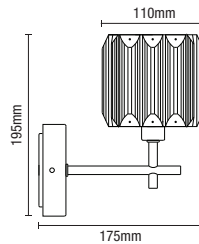

- Chrome finish
- Clear crystal shades



Code	Description	Lamp	Weight	Dimensions
SPA-33931-CHR	Pegasi Shield Wall Light	1 x 3W max LED G9	1.25kg	H:200 W:160 Proj:82mm
SPA-33932-CHR	Pegasi Wall Light	1 x 3W max LED G9	0.77kg	H:195 W:110 Proj:175mm

VELA

Flush Chandelier

IP44



- Clear glass crystal droplets
- Available in chrome & brass



IP44
Rated



Class 1



3.9kg

Code	Finish	Lamp	Dimensions
SPA-19713-CHR	Chrome	5 x 3W max LED G9	H:620 Dia:500mm
SPA-19713-SBRS	Satin Brass		

VELA

Flush Chandelier

IP44

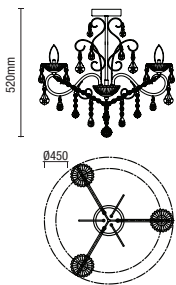

- Clear glass crystal droplets
- Available in chrome & brass



Code	Finish	Lamp	Dimensions
SPA-20182-CHR	Chrome	3 x 3W max LED G9	H:520 Dia:450mm
SPA-20182-SBRS	Satin Brass		

REENA

Ceiling/Wall Light

IP44



- Chrome finish
- Bulb covers



IP44
Rated

Class 1

Code	Lamp	Weight	Dimensions
SPA-28326-CHR	3 x 3W max LED G9	1.7kg	H:190mm Dia:410mm

CRUX

3 Light Ceiling Fitting

IP44

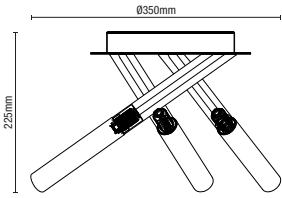

- Decorative tubular shades
- Available in 3 finishes



Code	Finish	Lamp	Dimensions
SPA-20829-MBLK	Matt Black	3 x 3W max LED G9	H225 x Dia350mm
SPA-20829-SBRS	Satin Brass		

RHODES

LED Bathroom Wall Light

400
LUMENS

IP44

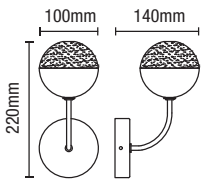

- Crackle effect diffuser
- 5W LED module (SMD)
- Lm/W: 80
- CRI: 80



Code	Finish	Power (w)	Colour (k)	Total Flux (lm)	Dimensions
SPA-36300-CHR	Chrome	5W	4000k	400	H220 x W100 x Proj140mm

GENE

Wall Light

IP44



- Glass cylinder shade
- Bulb covers for use in bathroom
- Matching items available
- Available in chrome & satin brass



Code	Finish	Lamp	Dimensions
SPA-31725-SATBRS	Satin Brass	1 x 3W max LED G9	H:205 W:100 Proj:165mm

GENE

Ceiling Light

IP44

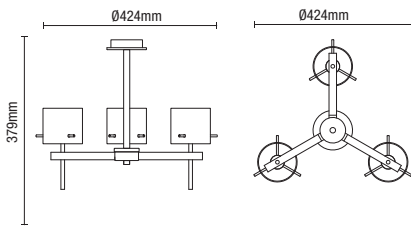

- Glass cylinder shade
- Bulb covers for use in bathroom
- Matching items available
- Available in chrome & satin brass



Code	Finish	Lamp	Dimensions
SPA-31726-SBRS	Satin Brass	3 x 3W max LED G9	H:379mm Dia:424mm

PORTO

Wall Light

IP44

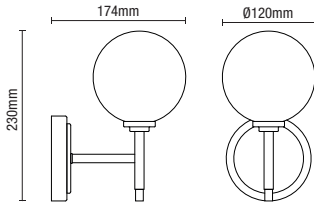

- Opal glass shade
- Matching items available
- Available in 2 finishes



Code	Finish	Lamp	Dimensions
SPA-31306-CHR	Chrome	1 x 3W max LED G9	H:230 W:120 Proj:174mm
SPA-31306-MBLK	Matt Black		

PORTO

Semi Flush

IP44

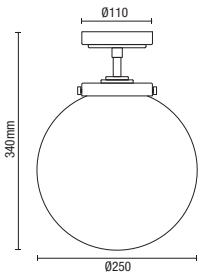

- Opal glass shade
- Matching items available
- Available in 3 finishes



Code	Finish	Lamp	Dimensions
SPA-31309-CHR	Chrome	1 x 10W max LED E27 GLS	H:340 Dia:250mm
SPA-31309-MBLK	Matt Black		

MILAN

LED Spotlight

Upto
960
LUMENS

IP44

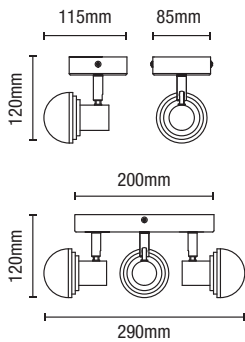

- 5W LED module (SMD) per head
- Lm/W: 64
- CRI: 80
- Hrs: 20,000
- Single spot can be wall or ceiling mounted



Code	Description	Power (w)	Colour (k)	Total Flux (lm)	Efficiency (lm/W)	Dimensions
SPA-31733-CHR	Milan 3 Light Spotlight	15W	3000k	960	64	L255 x W290 x H120mm
SPA-31732-CHR	Milan Single Spotlight	5W	3000k	320	64	Proj115 x W85 x H120mm

AMALFI

LED 1 Light Flush

450
LUMENS

IP44

NEW



- Chrome finish with opal acrylic diffusers
- 15W LED module (SMD)
- Lm/W: 63
- CRI: 80
- Hrs: 20,000

Code	Finish	Power (w)	Colour (k)	Total Flux (lm)	Efficiency (lm/W)	Dimensions
SPA-44466-CHR	Chrome	15W	4000k	450	30	H75 x W100 x D100mm
SPA-44466-MBLK	Matt Black					

AMALFI

LED 3 Light Flush

1386
LUMENS

IP44

NEW
COLOUR

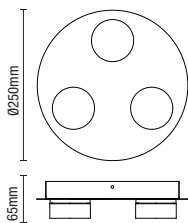

- Chrome finish with opal acrylic diffusers
- 14W LED module (SMD)
- Lm/W: 99
- CRI: 80
- Hrs: 20,000

IP44
Rated

4000K
CW

Class 2

1.14kg

Code	Finish	Power (w)	Colour (k)	Total Flux (lm)	Efficiency (lm/W)	Dimensions
SPA-31736-CHR	Chrome	14W	4000k	1386	99	H65 x Dia250mm
SPA-31736-MBLK	Matt Black					

AMALFI

LED 4 Light Bar

1780
LUMENS

IP44

NEW
COLOUR

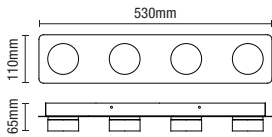

- Chrome finish with opal acrylic diffusers
- 20W LED module (SMD)
- Lm/W: 89
- CRI: 80
- Hrs: 20,000



Code	Finish	Power (w)	Colour (k)	Total Flux (lm)	Efficiency (lm/W)	Dimensions
SPA-31737-CHR	Chrome	20W	4000k	1780	89	L:530 W:110 H:65mm
SPA-31737-MBLK	Matt Black					

FREYA

3 Light Spotlight

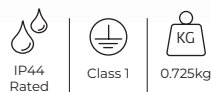
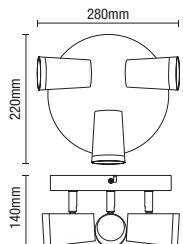

- Chrome finish
- Directable spotlights

Code	Finish	Lamp	Dimensions
SPA-35080-CHR	Chrome	3 x 7W max LED GU10	H:140 W:280 L:220mm
SPA-35080-BLK	Black		

FREYA

4 Light Bar Spotlight



- Chrome finish
- Directable spotlights

Code	Finish	Lamp	Dimensions
SPA-35081-CHR	Chrome	4 x 7W max LED GU10	H:140 W:80 L:780mm
SPA-35081-BLK	Black		

SCORPIUS

3 Light Spotlight

IP44



- Available in 3 finishes
- Directable spotlights



Code	Finish	Lamp	Dimensions
SPA-27405-CHR	Chrome		
SPA-27405-MBLK	Matt Black	3 x 7W max LED GU10	H:140 W:220 L:280mm
SPA-27405-BRS	Brass		

SCORPIUS

4 Light Bar Spotlight

IP44



- Available in 2 finishes
- Directable spotlights



Code	Finish	Lamp	Dimensions
SPA-22560	Chrome	4 x 7W max LED GU10	L:620 W:80 H:140mm
SPA-22560-MBLK	Matt Black		

DELPHI

LED Flush

900
LUMENS

IP44



- Glass opal diffuser
- Stylish & practical ceiling flush
- Available in 4 colour options
-

Large - 310mm

- 18W LED module (SMD)
- K: 4000
- Lm: 900
- Lm/W: 50
- Hrs: 20,000

 IP44
Rated

 4000K
CW

 Class 1

Code	Finish	Power (w)	Colour (k)	Total Flux (lm)	Efficiency (lm/W)	CRI	Dimensions
SPA-34047-CHR	Chrome						
SPA-34047-SNIC	Satin Nickel						
SPA-34047-BRS	Brass	18W	4000k	900	50	>80	H:85 Dia:310mm
SPA-34047-SBLK	Satin Black						

DELPHI

Flush

IP44



- Glass opal diffuser
- Stylish & practical ceiling flush
- Available in 4 colour options



Code	Finish	Lamp	Dimensions
SPA-34050-CHR	Chrome		
SPA-34050-SNIC	Satin Nickel		
SPA-34050-BRS	Brass	2 x 10W max E27 GLS	H:85 Dia:310mm
SPA-34050-SBLK	Satin Black		



TAURI

6W LED Wall/Ceiling 5 in 1 Light

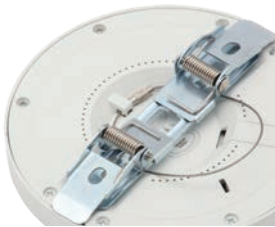

Multi-role bracket and CCT switch



- Super slim design: 15mm thickness
- Can be recessed, ceiling mounted or wall surface mounted
- Push-fit, drag-detach bracket
- Anti-drop hoop for safety installation
- Fast-fit terminal connector
- 4 colours of magnetic rings available
- 12,000 hours LED lifetime
- Switch between 3000K/4000K/6000K



Code	Finish	Description	Lamp	Lumen	Weight	Dimensions
SPA-34008-WHT	White	Tauri LED Light	6W LED	600	0.3kg	H:15 Dia:139mm
SPA-34010-SNIC	Satin Nickel					
SPA-34012-CHR	Chrome					
SPA-35711	Matt Black	Tauri Magnetic Ring (Fits 6W model)	-	-	0.11kg	H:15 Dia:139mm
SPA-35712	Satin Brass					

TAURI

12W LED Wall/Ceiling 5 in 1 Light

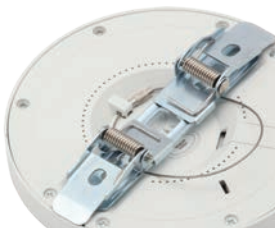

Multi-role bracket and CCT switch

- Super slim design: 15mm thickness
- Can be recessed, ceiling mounted or wall surface mounted
- Push-fit, drag-detach bracket
- Anti-drop hoop for safety installation
- Fast-fit terminal connector
- 4 colours of magnetic rings available
- 12,000 hours LED lifetime
- Switch between 3000K/4000K/6000K



Code	Finish	Description	Lamp	Lumen	Weight	Dimensions
SPA-35709	White	Tauri LED Light	12W LED	1200	0.42kg	H:15 Dia:164mm
SPA-35713	Satin Nickel					
SPA-35716	Chrome	Tauri Magnetic Ring (Fits 12W model)	-	-	0.17kg	H:15 Dia:164mm
SPA-35714	Satin Black					
SPA-35715	Satin Brass					

TAURI

18W LED Wall/Ceiling 5 in 1 Light

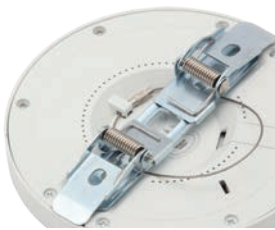

Multi-role bracket and CCT switch

- Super slim design: 15mm thickness
- Can be recessed, ceiling mounted or wall surface mounted
- Push-fit, drag-detach bracket
- Anti-drop hoop for safety installation
- Fast-fit terminal connector
- 4 colours of magnetic rings available
- 12,000 hours LED lifetime
- Switch between 3000K/4000K/6000K



Code	Finish	Description	Lamp	Lumen	Weight	Dimensions
SPA-34009-WHT	White	Tauri LED Light	18W LED	1800	0.58kg	H:15 Dia:217mm
SPA-34011-SNIC	Satin Nickel					
SPA-34013-CHR	Chrome					
SPA-35717	Matt Black	Tauri Magnetic Ring (Fits 18W model)	-	-	0.21kg	H:15 Dia:217mm
SPA-35718	Satin Brass					

TAURI

24W LED Wall/Ceiling 5 in 1 Light



2400
LUMENS

IP44

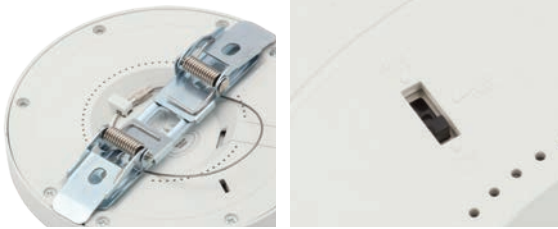

Multi-role bracket and CCT switch



- Super slim design: 15mm thickness
- Can be recessed, ceiling mounted or wall surface mounted
- Push-fit, drag-detach bracket
- Anti-drop hoop for safety installation
- Fast-fit terminal connector
- 4 colours of magnetic rings available
- 12,000 hours LED lifetime
- Switch between 3000K/4000K/6000K



60-250mm
Cut-out



IP44
Rated



CCT



Class 2

Code	Finish	Description	Lamp	Lumen	Weight	Dimensions
SPA-35710	White	Tauri LED Light	24W LED	2400	0.66kg	H:15 Dia:290mm
SPA-35719	Satin Nickel					
SPA-35722	Chrome					
SPA-35720	Matt Black	Tauri Magnetic Ring (Fits 24W model)	-	-	0.27kg	H:15 Dia:290mm
SPA-35721	Satin Brass					

ARIES

2 Light Wall Light

IP44



- Chrome finish
- Pull switch

IP44
Rated

Class 1

KG
0.8kg

Code

Lamp

Dimensions

SPA-PR-12744

2 x 3W max LED G9

Proj:115 W:360 H:60mm

AQUARIUS

Wall Light

IP44



- Chrome finish
- Pull switch



Code

SPA-PR-17146

Lamp

1 x 3W max LED G9

Dimensions

Proj:180 W:110 H:220mm

CALI

Square Tiltable Downlight

IP65

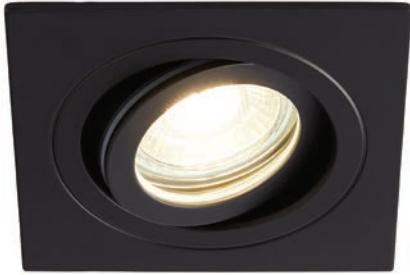

Tilted



Fixed



- Die-cast aluminium with glass lens
- Adjustable tilt, max 40°
- Available in 6 finishes



IP65
Rated



74mm
Cut-out



Class 2



0.17kg

Code	Finish	Lamp	Dimensions
SPA-38577-BRCOP	Brushed Copper	1 x 7W max LED GU10	L:82 W:82 H:100mm Cutout:74mm
SPA-35724	Matt White		
SPA-35725	Matt Black		
SPA-35727	Chrome		
SPA-35723	Satin Brass		
SPA-35726	Satin Nickel		

CHAI

Picture/Mirror Light

395
LUMENS

IP44



212 | SPA BATHROOM



- Available in 4 finishes
- Pull Switch
- 8W LED module (SMD)
- K: 3000
- Lm: 395
- Lm/W: 70
- CRI: 80
- Hrs: 20,000



Code	Finish	Power (w)	Colour (k)	Total Flux (lm)	Efficiency (lm/W)	Dimensions
SPA-30993-CHR	Chrome					
SPA-30993-SNIC	Satin Nickel					
SPA-30993-SBRS	Satin Brass	8W	3000k	395	70	H:80 W:410m Proj:160mm
SPA-30993-MBLK	Matt Black					

CORVUS

Wall Light

IP44

NEW
COLOUR



- Available in chrome, satin brass and satin black
- Pull switch



Code	Finish	Lamp	Dimensions
SPA-6888.014-CHR	Chrome		
SPA-6888.014-SBRS	Satin Brass	2 x 3W max LED G9	W:205 H:105 Proj:155mm
SPA-6888.014-SBLK	Satin Black		

ARA

Hollywood 5 Light Bar Wall Light

IP44



- Available in 3 finishes
- Pull switch



Code	Finish	Lamp	Dimensions
SPA-PR-13145	Chrome	5 x 3W max LED G9	W:680 H:80 Proj:110mm

ECTI

Illuminated Bathroom Mirror



435
LUMENS

IP44



- Mirrored glass
- Bathroom Zone 2
- Rocker ON/OFF switch
- Integrated shaver socket
- Can be mounted landscape or portrait
- 14.5W LED module (SMD)
- K: 5000
- Lm: 435
- Lm/W: 30



Shaver
Socket



IP44
Rated



5000K
DW



Class 1



6.65kg

Code

SPA-34035

Lamp

14.5W LED

Dimensions

H:700 W:500 Proj:56mm

FLEC

Illuminated Bathroom Mirror

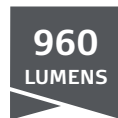

- Mirrored glass
- Bathroom Zone 2
- Touch switch
- Can be mounted landscape or portrait
- 14.5W LED module (SMD)
- K: 5000
- Lm: 960
- Lm/W: 48



Touch Switch



Demist Pad



IP44 Rated



5000K DW



Class 1



8.95kg

Code

SPA-34036

Lamp

20W LED

Dimensions

H:800 W:600 Proj:33mm

REF

Illuminated Bathroom Mirror

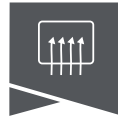

- Mirrored glass
- Bathroom Zone 2
- Touch switch
- Can be mounted landscape or portrait
- 21W LED module (SMD)
- K: 5000
- Lm: 630
- Lm/W: 30

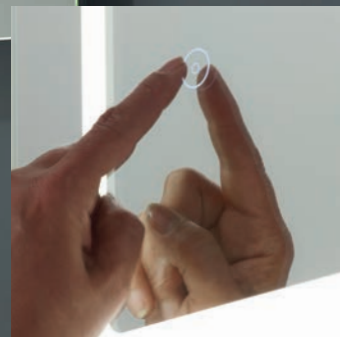

Touch Switch



Demist Pad



IP44 Rated



5000K DW



Class 1



6.3kg

Code

SPA-34037

Lamp

21W LED

Dimensions

H:700 W:500 Proj:46mm

NOR

Illuminated Bathroom Mirror



1536
LUMENS

IP44



- Mirrored glass
- Bathroom Zone 2
- Touch switch
- Can be mounted landscape or portrait
- 32W LED module (SMD)
- K: 5000
- Lm: 1536
- Lm/W: 48



Touch
Switch



Demist
Pad



IP44
Rated



5000K
DW



Class 1



6.7kg

Code

SPA-34038

Lamp

32W LED

Dimensions

H:800 W:600 Proj:46mm

ION

Illuminated Bathroom Mirror

1536
LUMENS

IP44



- Mirrored glass
- Bathroom Zone 2
- Rocker ON/OFF switch
- Can be mounted landscape or portrait
- 8W LED module (SMD)
- K: 5000
- Lm: 1536
- Lm/W: 128



IP44
Rated



5000K
DW



Class 1



3.7kg

Code

SPA-34039

Lamp

12W LED

Dimensions

H:500 W:400 Proj:46mm



NYX

Illuminated Bathroom Mirror

1690
LUMENS

IP44



- Mirrored glass
- Bathroom Zone 2
- Motion sensor switch
- 12W LED module (SMD)
- K: 5000
- Lm: 1690
- Lm/W: 140



IP44
Rated



5000K
DW



Class 1



6.9kg

Code	Power (w)	Colour (k)	Total Flux (lm)	Efficiency (lm/W)	CRI	Dimensions
SPA-35706	12W	5000k	1690	140	>80	Dia:600 Proj:35mm

ESK

Illuminated Bathroom Mirror



997
LUMENS

IP44

NEW



- 16W LED module (SMD)

Code	Power (w)	Colour (k)	Total Flux (lm)	Efficiency (lm/W)	CRI	Dimensions
SPA-44386	16W	4000k	997	62	>80	ø500 x D25mm

EXE

Illuminated Bathroom Mirror



1217
LUMENS

IP44

NEW



- 25W LED module (SMD)

Code	Power (w)	Colour (k)	Total Flux (lm)	Efficiency (lm/W)	CRI	Dimensions
SPA-44388	36.2W	4000k	1217	33	>80	H600 x W450 x D25mm



FAL

Illuminated Bathroom Mirror

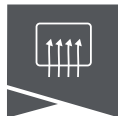

1308
LUMENS

IP44

NEW



- 36.2W LED module (SMD)

Code	Power (w)	Colour (k)	Total Flux (lm)	Efficiency (lm/W)	CRI	Dimensions
SPA-44391	36.2W	4000K	1308	36	>80	∅600 x 25mm



MAR

Illuminated Bathroom Mirror



1319
LUMENS

IP44

NEW

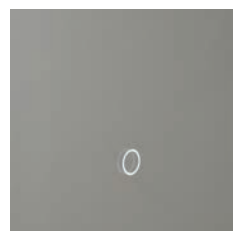

- 41W LED module (SMD)

Code	Power (w)	Colour (k)	Total Flux (lm)	Efficiency (lm/W)	CRI	Dimensions
SPA-44393	41W	4000k	1319	32	>80	H700 x W500 x D25mm

ROC

Illuminated Bathroom
Mirror



UPTO
472
LUMENS

IP44

NEW

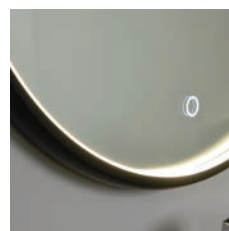

Code	Finish	Power (w)	Colour (k)	Total Flux (lm)	Efficiency (lm/W)	CRI	Dimensions
SPA-44396	Black	32W	4000k	321	10	>80	ø500 x D35mm
SPA-44397	Black	35W		472	13.5		ø600 x D35mm

LORI

Illuminated Bathroom Mirror

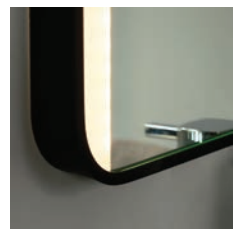
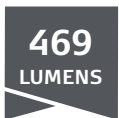

Code	Finish	Power (w)	Colour (k)	Total Flux (lm)	Efficiency (lm/W)	CRI	Dimensions
SPA-44482	Satin Brass	13W	4000k	469	36	>80	H710 x W510 x D40mm
SPA-44483	Matt Black						



ARTE

Illuminated Bathroom Cabinet



2190
LUMENS

IP44



- Soft close hinged single door
- Door mirrored on both sides
- Adjustable height tempered glass shelves
- Touch sensor ON/OFF switch
- Demist pad & shaver socket
- 34W LED module (SMD)
- K: 5000
- Lm: 2190
- Lm/W: 64



Shaver
Socket

Demist
Pad

Touch
Switch

IP44
Rated

5000K
DW

Class 1

KG

Code	Power (w)	Colour (k)	Total Flux (lm)	Efficiency (lm/W)	CRI	Dimensions
SPA-35707	34W	5000k	2190	64	>80	W:500 H:700 Proj:130mm



CULINA

KITCHEN

A range of modern LED kitchen lighting, including tape, under cabinet lights, link lights and plinth lights.

UNDER CABINET	234-241
KONECT PLUG & PLAY	242-248
TRACK LIGHTING	249-253
PLINTH LIGHTING	254-255



FONTE

LED Under Cabinet Light

UPTO
150
LUMENS

NO
DRIVER
REQ.



WARM WHITE
3000K

COOL WHITE
4000K

DAYLIGHT WHITE
6000K

- Mains connected - no driver required
- Brushed satin nickel finish with opal polycarbonate diffuser
- Available in 3000K/4000K/6000K
- 1m cable included
- 1.5W LED module (SMD)
- Lm: 150
- Lm/W: 100



Code	Lamp	Kelvin	Lumen	Dimensions
CUL-25319	1.5W LED	3000	130	H:126 W:145 Proj:32mm
CUL-21626	1.5W LED	4000	140	H:126 W:145 Proj:32mm
CUL-25219	1.5W LED	6000	150	H:126 W:145 Proj:32mm

POZZA

Recessed LED Under Cabinet Light



- Mains connected - no driver required
- Brushed satin nickel finish with opal polycarbonate diffuser
- Available in 3000K/4000K
- 1.5W LED module (SMD)
- Lm/W: 100

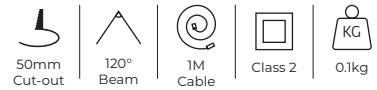

Code	Lamp	Kelvin	Lumen	Dimensions
CUL-25317	1.5W LED	3000	130	Dia:65 Proj:20mm
CUL-21624	1.5W LED	4000	140	Dia:65 Proj:20mm

LAGHETTO

LED Under Cabinet Light



- Mains connected - no driver required
- Brushed satin nickel finish with opal polycarbonate diffuser
- Available in 3000K/4000K/6000K
- 1.5W LED module (SMD)
- Lm/W: 100

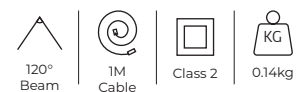

Code	Lamp	Kelvin	Lumen	Dimensions
CUL-25318	1.5W LED	3000	130	Dia:75 Proj:26mm
CUL-21625	1.5W LED	4000	140	Dia:75 Proj:26mm
CUL-25218	1.5W LED	6000	150	Dia:75 Proj:26mm

ARGI

LED Round Under Cabinet Light



WARM WHITE
3000K

COOL WHITE
4000K

DAYLIGHT WHITE
6000K

- Mains connected - no driver required
- Satin nickel finish with opal polycarbonate diffuser
- Can be recessed or surface mounted with removeable spacer
- Colour changing technology
- Switch between 3000K/4000K/6000K
- 3W LED module (SMD)
- Lm/W: 60



Code	Lamp	Lumen	Dimensions
CUL-35864	3W LED	180	Dia:75 H:29mm

ELLEN

LED Round Under Cabinet Light

- Mains connected - no driver required
- Satin nickel finish with opal polycarbonate diffuser
- Can be recessed or surface mounted with removeable spacer
- Colour changing technology
- Switch between 3000K/4000K/6000K
- 1.5W LED module (SMD)
- Lm/W: 80



Code	Lamp	Lumen	Dimensions
CUL-35860	1.5W LED	120	Dia:75 Proj:29mm

FARO

LED Triangle Under Cabinet Light

- Mains connected - no driver required
- Satin nickel finish with opal polycarbonate diffuser
- Colour changing technology
- Switch between 3000K/4000K/6000K
- 1.5W LED module (SMD)
- Lm/W: 80



Code	Lamp	Lumen	Dimensions
CUL-35861	1.5W LED	120	H:122 W:142 Proj:36mm

AYLA

LED Triangle Under Cabinet Light

- Mains connected - no driver required
- Satin nickel finish with opal polycarbonate diffuser
- Colour changing technology
- Switch between 3000K/4000K/6000K
- 3W LED module (SMD)
- Lm/W: 60



Code	Lamp	Lumen	Dimensions
CUL-35865	3W LED	180	H:122 W:142 Proj:36mm



LEGARE

CCT Under Cabinet Link Light



- Silver aluminium body with opal polycarbonate diffuser
- Switch between 3000K/OFF/4000K
- No driver required
- Supplied with 2m power lead
- Simple connection system

- Simple to butt connect fittings together



Code	Lamp	Lumen	Weight	Length	Dimensions
CUL-34223-CCT	4W LED	400	0.21kg	300mm	L:300 W:24 Proj:34mm
CUL-34224-CCT	7W LED	700	0.3kg	500mm	L:500 W:24 Proj:34mm
CUL-34225-CCT	12W LED	1000	0.4kg	870mm	L:870 W:24 Proj:34mm

LEGARE

LINK LEAD

- Enables you to connect 2 legare or bude link lights on the same circuit
- Available in 2 lengths
- IEC C8 cable

Code	Length
CUL-21665	0.5 meters
CUL-21666	1 meter

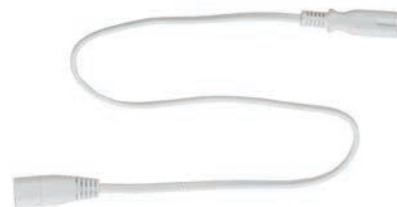



240 | CULINA KITCHEN

LIGERO

Rechargeable Under Cabinet Light

UPTO
350
LUMENS



- Ideal for multiple applications
- No wiring required
- PIR sensor with 3M detection distance
- AUTO ON/ALWAYS ON/OFF function
- 4 hours charge time

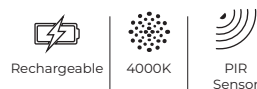

Code	Power (w)	Colour (k)	Total Flux (lm)	Battery	Charge Time	Run Time	Dimensions
CUL-37386	1W	4000k	90	750mAh Li-ion	4 Hours	4 Hours	L:200 W:40 H:9mm
CUL-37387	2W	4000k	160	1100mAh Li-ion	4 Hours	5 Hours	L:400 W:40 H:9mm
CUL-37388	3W	4000k	230	1500mAh Li-ion	4 Hours	5 Hours	L:564 W:40 H:9mm
CUL-37389	4W	4000k	350	2200mAh Li-ion	4 Hours	5 Hours	L:864 W:40 H:9mm



Plug and play system

242

CULINA KITCHEN

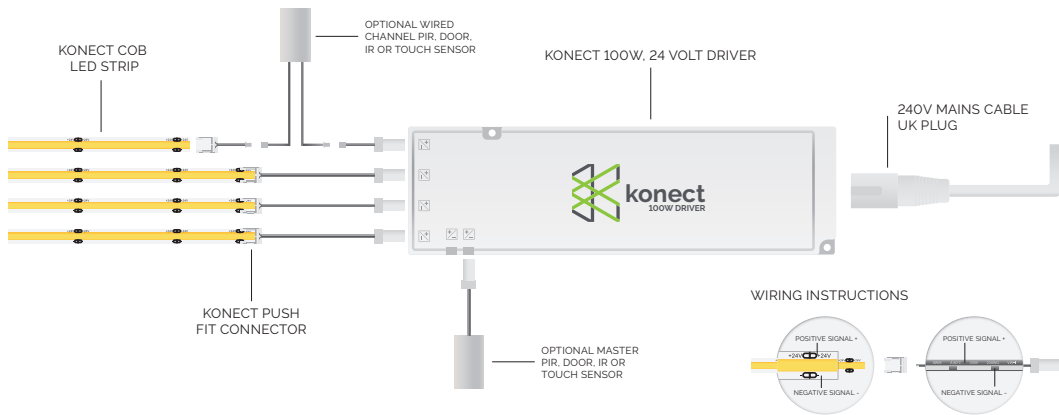

The Konect plug and play system features revolutionary wiresafe technology. Designed to protect all ports from overloading, short circuits and electrical surges, ensuring lighting systems stay as safe as possible. In turn conforming to BS7671 Regulations.

The new Konect connectors on each components are designed to only fit into the respective ports further enhancing safety. Offering this balance of maximum safety and simplicity means less need for electrical qualifications on installation, saving you time and money on your next lighting project.

We have a range of drivers with a range of up to 7 connection ports and can power up to 100 watts worth of LED Lights in one 24 Volt lighting system. Full customisable with UK plugs available in 3 lengths, extension cables and a range of lighting you will be sure to find something suitable for your needs.

SLIMLINE

Under Cabinet Spotlight

180
LUMENS



243

CULINA KITCHEN

- Brushed steel finish
- 5W (SMD) LED
- Available in warm white (3000k) and cool white (4000k)
- Plug & Play with Konect drivers
- Easy to install



Code	Finish	Power (w)	Colour (k)	Total Flux (lm)	Dimensions
CUL-37797	Brushed Steel	5W	3000k	350	L:190 x W:70 Proj:4mm
CUL-37798	Brushed Steel		4000k		

RECESSED/SURFACE

Under Cabinet Spotlight

150
LUMENS



- Brushed steel finish
- Designed for surface mouting or recessed
- 1.8W (SMD) LED
- Available in warm white (3000k) and cool white (4000k)
- Plug & Play with Konect drivers
- Easy to install

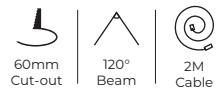

Code	Finish	Power (w)	Colour (k)	Total Flux (lm)	Dimensions
CUL-37795	Brushed Steel	1.8W	3000k	150	Dia:65 H:10mm

IR MINI

Under Cabinet/Drawer Light

UPTO
460
LUMENS



- Infrared sensor ideal for kitchen drawers and wardrobes
- Available in warm white (3000k) and cool white (4000k)
- Plug & Play with Konect drivers
- Easy to install



Code	Finish	Power (w)	Colour (k)	Total Flux (lm)	Dimensions
CUL-37787	Brushed Steel	3.5W	3000k	220	L:563 x W:13 Proj:15.5mm
CUL-37789	Brushed Steel		4000K		
CUL-37788	Brushed Steel	5.2W	3000k	460	L:863 x W:13 Proj:15.5mm
CUL-37790	Brushed Steel		4000k		

8MM LED COB

Flexible Strip

UPTO
934
LUMENS



246

CULINA KITCHEN

- Flexible 12W/m LED COB tape
- CRI: >90
- Can be cut every 60mm
- 5m roll
- Available in warm white (3000k) and cool white (4000k)
- Plug & Play with Konect drivers
- Requires power cord
- Easy to install



Code	Power (w)	Colour (k)	CRI	Total Flux (lm)	Length
ELA-35750	12W/m	3000k	>90	150	5m
ELA-37551		4000k	>90		

60W/24V DRIVER/CONVERTER



- Plug & Play with Konec sensors, dimmers and lighting
- Driver applies to BS7671 regulations
- Input: AC200-240V
- Output:24V

Code	Load	Output Sockets	Dimensions
CUL-37770	60W	7 ports	L:189 W:55 H:15mm

24W/24V DRIVER/CONVERTER



- Plug & Play with Konec sensors, dimmers and lighting
- Driver applies to BS7671 regulations
- Input: AC200-240V
- Output:24V

Code	Load	Output Sockets	Dimensions
CUL 37768	24W	5 ports	L:138 W:55 H:18mm

100W/24V DRIVER/CONVERTER



- Plug & Play with Konec sensors, dimmers and lighting
- Driver applies to BS7671 regulations
- Input: AC200-240V
- Output:24V

Code	Load	Output Sockets	Dimensions
CUL-37771	100W	7 ports	L:239 W:56 H:18mm

36W/24V DRIVER/CONVERTER



- Plug & Play with Konec sensors, dimmers and lighting
- Driver applies to BS7671 regulations
- Input: AC200-240V
- Output:24V

Code	Load	Output Sockets	Dimensions
CUL 37769	36W	3 ports	L:148 W:55 H:18mm

MICRO DISTRIBUTOR



- Connect up to 6 accessories using 1 port from your driver

Code	Connector	Cable Length	Output Sockets	Dimensions
CUL-37786	Micro24	140mm	6 ports	L:60 W:45 H:45mm

KONECT

ACCESSORIES



UK PLUG TO 'FIGURE-8' (C7) TYPE MAINS LEAD

Code	Input	Cable Length	Colour
CUL-37783	AC200-240V	1000mm	White
CUL-37784	AC200-240V	1500mm	White
CUL-37785	AC200-240V	1800mm	White

EXTENSION CABLE

Code	Connector	Cable Length	Colour
CUL-37772	Micro 24 male/female connector	1200mm	White
CUL-37773	Micro 24 male/female connector	1800mm	White
CUL-37774	Micro 24 male/female connector	2400mm	White

KONECT

SENSORS



IR DOOR SENSOR

The infrared door sensor automatically senses when the cupboard door is opened and switches the light on, and when the cupboard door is shut the lights are instantly switched off, saving energy and money.

Code	Control Mode	Max Load	Cable Length
CUL-37775	Master	-	1500mm
CUL-37776	Channel	60W	2 x 1500mm

HAND MOTION SENSOR

Simply swipe your hand below the sensor within a 8cm distance enabling you to switch on and off any lighting without touching any buttons.

Code	Control Mode	Max Load	Cable Length
CUL-37781	Master	-	1500mm
CUL-37782	Channel	60W	2 x 1500mm

PIR SENSOR

Turns on the lighting when movement is detected within a 3m distance. The sensor has a 35 second timing delay so once no further movement is detected the lighting will power off. This can be recessed or mounted flush with the extra bracket provided.

Code	Control Mode	Max Load	Cable Length
CUL-37777	Master	-	1500mm
CUL-37778	Channel	60W	2 x 1500mm

TOUCH SENSOR

The touch sensor features a blue backlit light has a slimline design and is great for a recessed application. Short touch for on/off function or long press for dimming.

Code	Control Mode	Max Load	Cable Length
CUL-37779	Master	-	1500mm
CUL-37780	Channel	60W	2 x 1500mm

CAYO/CORY

1 Head Track Head Light

NEW



Black



Satin Nickel



Satin Brass



Class 1



0.18kg

Code	Colour	Lamp	Dimensions
CUL-44403-BLK	Black	7W max LED GU10	H177 x W35 x D80mm
CUL-44403-WHT	White		
CUL-44404-SBRS	Satin Brass/Black		
CUL-44405-SNIC	Satin Nickel/Black		

CAYO

3 Head Track Light Kit



- Ceiling cup to track insert supplied with 0.5m cable and 1m track
- Constructed from steel & ABS plastic
- Available in 2 finishes
- Fully adjustable lamp heads 330° rotation and 90° tilt
- Matching compatible track in the range



Class 1



1.2kg

Code	Colour	Lamp	Dimensions
INL-41730-BLK	Black	3 x 7W max LED GU10	L:1000 Proj:180mm
INL-41730-WHT	White		

CAYO

5 Head Track Light Kit



- Ceiling cup to track insert supplied with 0.5m cable and 2 x 0.8m track
- Constructed from steel & ABS plastic
- Available in 2 finishes
- Fully adjustable lamp heads
330° rotation and 90° tilt
- Matching compatible track in the range



Class 1



2.07kg

Code	Colour	Lamp	Dimensions
INL-41731-BLK	Black	5 x 7W max LED GU10	2 x L:800 Proj:180mm
INL-41731-WHT	White	5 x 7W max LED GU10	2 x L:800 Proj:180mm

TOR

Single Circuit Track



- 220-240V
- Die-cast Aluminium and ABS construction
- Includes 1 x live end & 1 x dead end



Code	Colour	Length	Dimensions
CUL-21637	White	1000mm	L:1000 W:37 Proj:17mm
CUL-21638	White	1500mm	L:1500 W:37 Proj:17mm
CUL-21639	White	2000mm	L:2000 W:37 Proj:17mm
CUL-26333	Black	1000mm	L:1000 W:37 Proj:17mm
CUL-26334	Black	1500mm	L:1500 W:37 Proj:17mm
CUL-26335	Black	2000mm	L:2000 W:37 Proj:17mm

LUSTRO

Track Light



- For use with Tor Single Circuit Track
- Steel and ABS construction



Code	Colour	Lamp	Dimensions
CUL-21660	White	1 x 7W max LED GU10	H:103 Proj:89mm
CUL-26346	Black	1 x 7W max LED GU10	H:103 Proj:89mm

LUCIDO

Track Light



- For use with Tor Single Circuit Track
- Die-cast Aluminium and ABS construction



Class 1



0.13kg

Code	Colour	Lamp	Dimensions
CUL-21658-WHT	White	1 x 7W max LED GU10	H:135 Proj:75mm
CUL-26345-BLK	Black	1 x 7W max LED GU10	H:135 Proj:75mm

RIBALTA

Track Light



- For use with Tor Single Circuit Track
- Die-cast Aluminium and ABS construction



Class 1



0.29kg

Code	Colour	Lamp	Dimensions
CUL-21656	White	1 x 7W max LED GU10	H:200 Proj:78mm
CUL-26344	Black	1 x 7W max LED GU10	H:200 Proj:78mm

TRACK ACCESSORIES



PENDANT ADAPTER FITS FLUSH IN TRACK

White	Black	Description	Dimensions
CUL-26342	CUL-26341	Flexible Connector	L:296 W:35 Proj:17mm
CUL-21645	CUL-26337	Double Live End Connector	L:184 W:35 Proj:17mm
CUL-33996	CUL-33996-BLK	Track Pendant Adapter	L:81 W:34 Proj:46mm
CUL-21651	CUL-26339	T Live End Connector	L:109 W:183 Proj:17mm
CUL-21649	CUL-26340	X Live End Connector	L:183 W:183 Proj:17mm
CUL-21647	CUL-26338	L Live End Connector	L:109 W:109 Proj:17mm
CUL-21643	CUL-26336	Butt Connector	L:79 W:35 Proj:17mm
CUL-21653	CUL-26332	Track Pendant Adapter	L:39 W:36 Proj:46mm

SUSPENSION KITS



Code	Dimensions
CUL-30710	L:1000mm
CUL-30711	L:2000mm

ROUND

Plinth Light

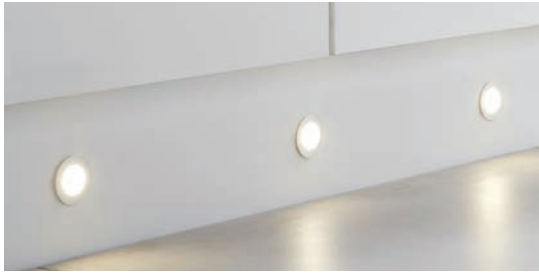

- Matt silver finish
- Super slim profile
- 1.2W (SMD) LED
- Available in warm white (3000k) and cool white (4000k)
- Plug & Play with Konect drivers
- Easy to install

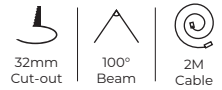

Code	Finish	Power (w)	Colour (k)	Total Flux (lm)	Dimensions
CUL-37791	Matt Silver	1.2W	3000k	100	Dia:35 H:13.5mm
CUL-37792	Matt Silver		4000k		

SQUARE

Plinth Light

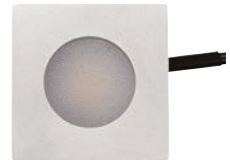

- Matt silver finish
- Super slim profile
- 1.2W (SMD) LED
- Available in warm white (3000k) and cool white (4000k)
- Plug & Play with Konect drivers
- Easy to install

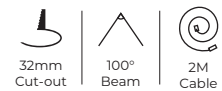

Code	Finish	Power (w)	Colour (k)	Total Flux (lm)	Dimensions
CUL-37793	Matt Silver	1.2W	3000k	100	L:35 W:35 H:13.5mm
CUL-37794	Matt Silver		4000k		

OHIO

Circular Plinth Light

20
LUMENS

IP65



- Mains connected - no driver required
- Brushed steel finish with opal polycarbonate diffuser
- Available in 3000K/6000K
- 0.5W LED module (SMD)



IP65
Rated



35mm
Cut-out



1M
Cable



Class 2



0.13kg

Code	Lamp	Kelvin	Lumen	Dimensions
CUL-26465-WW	0.5W LED	3000	20	Dia:40mm
CUL-26465	0.5W LED	6000	20	Dia:40mm



INLIGHT

INDOOR

Indoor lighting including a comprehensive range of decorative cable sets, shades and our new Illuminate task lighting. LED Lamps with attractive design and energy saving performance, INLIGHT LED lamps superbly compliment the Forum Lighting range.

PLASTER LIGHTS	258-262
SPOTLIGHTS	263-266
RECESSED/DOWNLIGHTS	267-268
PENDANT CABLE SETS	269-271
PICTURE LIGHTS	272-273
LED LAMPS	274-281

UBEDA

Downlight



PAINT
TO MATCH
DECOR

- White plaster finish
- Can be painted to match decor



Class 2



0.4kg

Code	Lamp	Dimensions
INL-37213	1 x 7W max LED GU10	Dia:70 H:110mm

CADIZ

Tiltable Downlight



PAINT
TO MATCH
DECOR

- White plaster finish
- Can be painted to match decor



Class 1



1.75kg

Code	Lamp	Dimensions
INL-37214	1 x 7W max LED GU10	Dia:135m H:160mm

CABRA

Flush Downlight



PAINT
TO MATCH
DECOR

- White plaster finish
- Can be painted to match decor



Class 1



0.4kg

Code	Lamp	Dimensions
INL-37211	1 x 7W max LED GU10	Dia:130 H:50mm

CARMONA

Up/Down Wall Light

PAINT
TO MATCH
DECOR



- White plaster finish
- Can be painted to match decor



Code	Finish	Lamp	Dimensions
INL-37225	White	2 x 7W max LED GU10	H:250 W:70 Proj:95mm

GETXO

Up/Down Wall Light

PAINT
TO MATCH
DECOR



- White plaster finish
- Can be painted to match decor



Code	Finish	Lamp	Dimensions
INL-37226	White	2 x 6W max LED E14 Candle	H:70 W:350 Proj:105mm

MONTILLA

Up/Down Light

PAINT
TO MATCH
DECOR

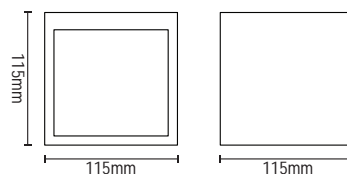

- White plaster finish
- Can be painted to match decor



Code	Lamp	Dimensions
INL-37219	1 x 3W max LED G9	H:115 W:115 Proj:115mm

OSUNA

Up/Down Light

PAINT
TO MATCH
DECOR

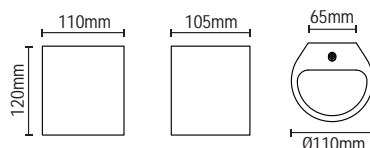

- White plaster finish
- Can be painted to match decor



Code	Lamp	Dimensions
INL-37224	1 x 3W max LED G9	H:120 W:110 Proj:105mm

MARTOS

Up/Down Light

PAINT
TO MATCH
DECOR

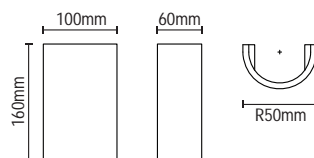

- White plaster finish
- Can be painted to match decor



Code	Lamp	Dimensions
INL-37221	1 x 3W max LED G9	H:160 W:100 Proj:60mm

MARTOS

Round Up/Down Light

PAINT
TO MATCH
DECOR

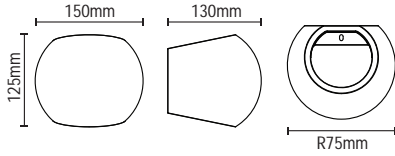

- White plaster finish
- Can be painted to match decor



Class 1



0.95kg



Code	Lamp	Dimensions
INL-37222	1 x 3W max LED G9	H:1205 W:150 Proj:130mm

BAZA

Up/Down Light

PAINT
TO MATCH
DECOR

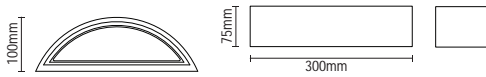

- White plaster finish
- Can be painted to match decor



Class 1



1.2kg



Code	Lamp	Dimensions
INL-37220	1 x 6W max LED E14 Candle	H:75 W:300 Proj:100mm

RHONDA

Up/Down Light

PAINT
TO MATCH
DECOR

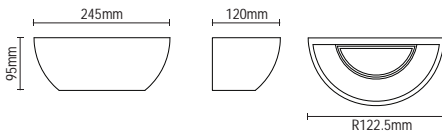

- White plaster finish
- Can be painted to match decor



Class 1



1.05kg



Code	Lamp	Dimensions
INL-37223	1 x 6W max LED E14 Candle	H:95 W:245 Proj:122.5mm

TELDE

Wall Uplighter

PAINT
TO MATCH
DECOR



- White plaster finish
- Can be painted to match decor



Code	Lamp	Dimensions
INL-38609	1 x 10W max LED E27 GLS	H:105 W:425 Proj:212mm

MAO

Wall Uplighter

PAINT
TO MATCH
DECOR

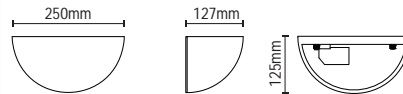

- White plaster finish
- Can be painted to match decor



Code	Lamp	Dimensions
INL-38610	1 x 10W max LED E27 GLS	H:125 W:250 Proj:127mm

TOLEDO

Wall Uplighter

PAINT
TO MATCH
DECOR

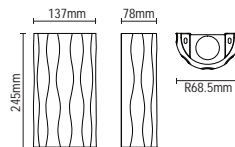

- White plaster finish
- Integral LED option
- Can be painted to match decor



Code	Lamp	Dimensions
INL-38612	2 x 7W max LED GU10	H:245 W:137 Proj:78mm

ELARA

Wall Spotlight



- Satin nickel and chrome finish
- Contemporary styling
- ON/OFF toggle switch



Class 1



0.4kg

Code	Lamp	Dimensions
INL-740000-SNIC	1 x 7W max LED GU10	L:110 W:100 H:115mm

ELARA

4 Light Bar Spotlight



- Satin nickel and chrome finish
- Contemporary styling
- Adjustable lamps



Class 1



1.33kg

Code	Lamp	Dimensions
INL-598410-SNIC	4 x 7W max LED GU10	L:800 W:165 H:145mm

ELARA

3 Light Plate Spotlight



- Satin nickel and chrome finish
- Contemporary styling
- Adjustable lamps



Class 1

1.33kg

Code	Lamp	Dimensions
INL-598310-SNIC	3 x 7W max LED GU10	H:115 Dia:290mm

PEDRO

Spotlight



- Black Chrome finish
- Contemporary styling
- Adjustable lamps



Class 1

Code	Description	Lamp	Weight	Dimensions
INL-28203-BCHR	Pedro 3 Light Plate Spotlight	3 x 7W max LED GU10	1.2kg	H:120 Dia:260mm

PEDRO

4 Light Plate Spotlight



- Black Chrome finish
- Contemporary styling
- Adjustable lamps



Class 1

1.65kg

Code	Lamp	Dimensions
INL-28205-BCHR	4 x 7W max LED GU10	W:220 L:220 H:120mm

HARVEY

Spotlight



- Contemporary styling
- Ceiling or wall mounted
- 350° rotation
- Available in 4 finishes



Class 1

0.19kg

Code	Finish	Lamp	Dimensions
INL-31775-SNIC	Satin Nickel	1 x 7W max LED GU10	L:100 W:85 H:120mm
INL-31775-BLK	Black		
INL-31775-WHT	White		
INL-31775-SBRS	Satin Brass		

HARVEY

3 Light Plate Spotlight



Class 1



0.75kg

- Contemporary styling
- Ceiling or wall mounted
- 350° rotation
- Available in 4 finishes

Code	Finish	Lamp	Dimensions
INL-31776-SNIC	Satin Nickel		
INL-31776-BLK	Black		
INL-31776-WHT	White	3 x 7W max LED GU10	Dia:215 H:120mm
INL-31776-SBRS	Satin Brass		

HARVEY

4 Light Bar Spotlight



Class 1



0.75kg

- Contemporary styling
- Ceiling or wall mounted
- 350° rotation
- Available in 4 finishes

Code	Finish	Lamp	Dimensions
INL-31723-SNIC	Satin Nickel		
INL-31723-BLK	Black		
INL-31723-WHT	White	4 x 7W max LED GU10	L:774 W:85 H:120mm
INL-31723-SBRS	Satin Brass		

PASTO

Adjustable Downlight



Class 2

Code	Description	Finish	Lamp	Dimensions
INL-38617-BLK	Pasto Single Adjustable Downlight	Black	1 x 7W max LED GU10	L:92 W:92 H:3mm Cutout:80mm
INL-38617-BRS		Polished Brass		
INL-38617-SIL		Polished Silver		
INL-38617-WHT		White		
INL-38618-BLK	Pasto Double Adjustable Downlight	Black	2 x 7W max LED GU10	L:174 W:92 H:3mm Cutout:160 x 80mm
INL-38618-BRS		Polished Brass		
INL-38618-SIL		Polished Silver		
INL-38618-WHT		White		

CALI

Tiltable Downlight

IP65



Tilted



Fixed



- Die-cast aluminium with glass lens
- Adjustable tilt, max 40°
- Available in 6 finishes



Code	Finish	Lamp	Dimensions
SPA-30841-BRCOP	Brushed Copper		
SPA-30841-MWHT	Matt White		
SPA-30841-MBLK	Matt Black	1 x 7W max LED GU10	Dia:92 H:115mm
SPA-30842-CHR	Chrome		Cutout:78mm
SPA-30842-SBRS	Satin Brass		
SPA-30842-SCHR	Satin Chrome		

CALI

Square Tiltable Downlight

IP65

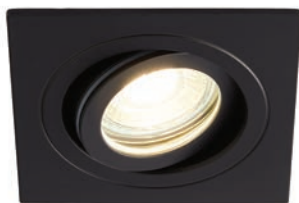

Tilted



Fixed



- Die-cast aluminium with glass lens
- Adjustable tilt, max 40°
- Available in 6 finishes



Code	Finish	Lamp	Dimensions
SPA-38577-BRCOP	Brushed Copper		
SPA-35724	Matt White		
SPA-35725	Matt Black	1 x 7W max LED GU10	L:82 W:82 H:115mm
SPA-35727	Chrome		Cutout:78mm
SPA-35723	Satin Brass		
SPA-35726	Satin Nickel		

DALE

E27/ES CABLE SET



- Fits E27 lamps
- Can be fitted to almost any easyfit shade
- Adjustable height
- Available in 5 finishes
- Vintage styling
- Lamps supplied separately

Code	Description	Lamp	Dimensions
INL-27988-ABRS	Antique Brass Cable Set with Champagne Twisted Cable	1 x 42W Max E27	Dia:105 H:1000mm
INL-27988-ACOP	Antique Copper Cable Set with Black Twisted Cable	1 x 42W Max E27	Dia:105 H:1000mm
INL-27988-PEW	Pewter Cable Set with Black Twisted Cable	1 x 42W Max E27	Dia:105 H:1000mm
INL-27988-BRZ	Bronze Cable Set with Black Twisted Cable	1 x 42W Max E27	Dia:105 H:1000mm
INL-27988-SNIC	Satin Nickel Cable Set with Grey Twisted Cable	1 x 42W Max E27	Dia:105 H:1000mm



PADUA

Ceiling Light



- Supplied with hook and loop fixing kit to create your own style
- Can be fitted with most easyfit shades
- Height adjustable



Class 1

Code	Finish	Lamp	Dimensions	Weight
INL-31789-ACOP	Copper/Black	7 x 10W max LED E27 GLS	Min H:110mm Max H:2000mm	1.81kg



CHAI

Picture/Mirror Light

395
LUMENS

IP44



- Available in 4 finishes
- Pull Switch
- 8W LED module (SMD)
- K: 3000
- Lm: 395
- Lm/W: 70



Code	Finish	Power (w)	Colour (k)	Total Flux (lm)	Efficiency (lm/W)	Dimensions
SPA-30993-CHR	Chrome					
SPA-30993-SNIC	Satin Nickel					
SPA-30993-SBRS	Satin Brass	8W	3000k	395	70	H:80 W:410 Proj:160mm
SPA-30993-MBLK	Matt Black					



- 360° Beam angle
- Dimmable
- Available in amber or smoke



LARGE VINTAGE LAMPS

E27/ES



INL-34028-AMB

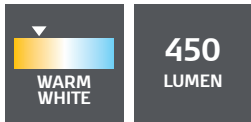

INL-34029-AMB

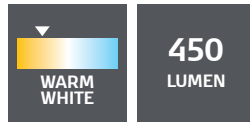

INL-34030-AMB

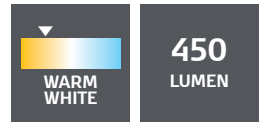

Code	Description	Kelvin	Lumen	Dimensions
INL-34028-AMB	G180 6W LED E27 Filament Lamp	2000	450	Dia:180 H:230mm
INL-34029-AMB	A165 6W LED E27 Filament Lamp	2000	450	Dia:165 H:300mm
INL-34030-AMB	BT180 6W LED E27 Filament Lamp	2000	450	Dia:180 H:360mm

VINTAGE LAMPS

E27/ES





580
 LUMEN
 DIMMABLE





650
 LUMEN
 DIMMABLE



400
 LUMEN
 DIMMABLE





450
 LUMEN
 DIMMABLE

Code	Description	Colour	Kelvin	Lumen	Dimensions
INL-ST64-LED-ES-TNT	ST64 6W E27 LED Filament Lamp	Tinted	2000	580	Dia:64 H:140mm
INL-ST64-LED-BC-TNT	ST64 6W B22 LED Filament Lamp	Tinted	2000	580	Dia:64 H:140mm
INL-ST64-LED-ES-CLR	ST64 6W E27 LED Filament Lamp	Clear	2000	650	Dia:64 H:140mm
INL-ST64-LED-BC-CLR	ST64 6W B22 LED Filament Lamp	Clear	2000	650	Dia:64 H:140mm
INL-G80-LED-ES-TNT	G80 4W E27 LED Filament Lamp	Tinted	2000	400	Dia:80 H:120mm
INL-G80-LED-ES-CLR	G80 4W E27 LED Filament Lamp	Clear	2000	450	Dia:80 H:120mm

VINTAGE LAMPS

E27/ES





580
 LUMEN
 DIMMABLE





650
 LUMEN
 DIMMABLE





165
 LUMEN
 DIMMABLE



180
 LUMEN
 DIMMABLE



350
 LUMEN
 DIMMABLE

Code	Description	Colour	Kelvin	Lumen	Dimensions
INL-G95-LED-ES-TNT	G95 6W E27 LED Filament Lamp	Tinted	2000	580	Dia:95 H:140mm
INL-G95-LED-ES-CLR	G95 6W E27 LED Filament Lamp	Clear	2000	650	Dia:95 H:140mm
INL-C35L-LED-SES-TNT	C35L 2W E14 LED Filament Lamp	Tinted	2000	165	Dia:35 H:120mm
INL-C35L-LED-SES-CLR	C35L 2W E14 LED Filament Lamp	Clear	2000	180	Dia:35 H:120mm
INL-A60-LED-ES-TNT	A60 4W E27 LED Filament Lamp	Tinted	2200	350	Dia:60 H:120mm

FILAMENT

LED LAMPS



600
LUMEN

DIMMABLE



600
LUMEN

DIMMABLE



400
LUMEN

DIMMABLE



400
LUMEN

DIMMABLE

Code	Bulb Shape	Cap Type	Power (w)	Colour (k)	Total Flux (lm)	Efficiency (lm/W)	Beam Angle	Dimensions
INL-36014	GLS (Classic)	B22	6W	3000k	600	100lm/W	360°	Dia:60 H:108mm
INL-36013	GLS (Classic)	E27	6W	Warm White	600			Dia:60 H:108mm
INL-36012	Candle	E14	4W	Warm White	400	100lm/W	360°	Dia:35 H:100mm
INL-36017	GLS (Classic)	B22	6W	4000k	600			Dia:60 H:108mm
INL-36016	GLS (Classic)	E27	6W	Cool White	600	100lm/W	360°	Dia:60 H:108mm
INL-36015	Candle	E14	4W	Cool White	400			Dia:35 H:100mm

G9 CAPSULE

LED LAMPS



- Available as singles, 3 pack or 6 packs
- Warm white 3000k or cool white 4000k colour temperatures

Warm White 3k	Cool White 4k	Description	Pack Size	Lumen	Dimmable	Dimensions
INL-42264	INL-42265	5W G9 LED	Single	470lm	Non Dimmable	Dia. 16.5 H:61mm
INL-42266	INL-42267	Clear	3 Pack			
INL-42270	INL-42271	8W G9 LED	Single	850lm	Dimmable	Dia. 18 H:75mm
INL-42272	INL-42273	Clear	3 Pack			
INL-42276	INL-42277	3.5W G9 LED	Single	330lm	Dimmable	Dia. 17 H:50mm
INL-42278	INL-42279	Frosted	3 Pack			
INL-42282	INL-42283	6.7W G9 LED	Single	550lm	Dimmable	Dia. 21 H:69mm
INL-42284	INL-42285	Frosted	3 Pack			

G9 CAPSULE

LED LAMPS

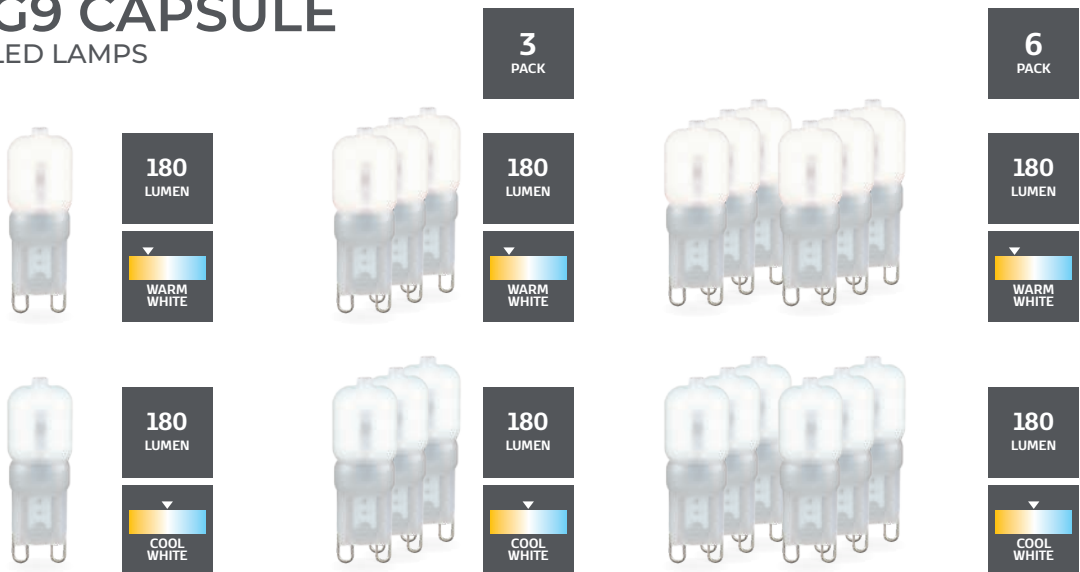

Code	Description	Pack Size	Kelvin	Lumen	Dimensions
INL-28573	2.5W G9 LED Lamp	Single	3000	180	W:16 H:48mm
INL-28575	2.5W G9 LED Lamp	3 Pack	3000	180	W:16 H:48mm
INL-28577	2.5W G9 LED Lamp	6 Pack	3000	180	W:16 H:48mm
INL-28574	2.5W G9 LED Lamp	Single	4000	180	W:16 H:48mm
INL-28576	2.5W G9 LED Lamp	3 Pack	4000	180	W:16 H:48mm
INL-28578	2.5W G9 LED Lamp	6 Pack	4000	180	W:16 H:48mm

GU10

LED LAMPS



400
LUMEN

38°
BEAM
ANGLE



400
LUMEN

38°
BEAM
ANGLE

Code	Description	Hours	Kelvin	Lumen	Dimmable	Dimensions
INL-34150-3K	5W LED GU10 LED Lamp	30000	3000	400	-	Dia:50 H:53mm
INL-34151-3K	5W LED GU10 LED Lamp	30000	3000	400	Yes	Dia:50 H:53mm
INL-34150-4K	5W LED GU10 LED Lamp	30000	4000	400	-	Dia:50 H:53mm
INL-34151-4K	5W LED GU10 LED Lamp	30000	4000	400	Yes	Dia:50 H:53mm

DUSK TILL DAWN (PHOTOCELL)

LED LAMPS



800
LUMEN



800
LUMEN

Code	Description	Hours	Kelvin	Lumen	Dimensions
INL-29464-WW	9W LED E27 D2D LED Lamp	40000	2700	800	Dia:60mm H:115mm
INL-29464-CW	9W LED E27 D2D LED Lamp	40000	4000	800	Dia:60mm H:115mm
INL-29465-CW	9W LED B22 D2D LED Lamp	40000	4000	800	Dia:60mm H:115mm

CCT

LED LAMPS

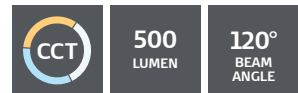
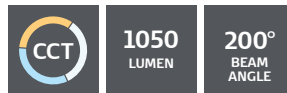
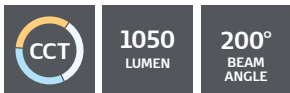

- 3 colour choices (Colour Temperature Switchable)
- Not dimmable
- Switch between 3000K warm white, 4000K cool white and 6000K daylight white

Code	Description	Hours	Kelvin	Lumen	Dimensions
INL-34400	6W LED GU10 LED Lamp	25000	CCT	500	Dia:50 H:53mm
INL-34401	12W LED E27 GLS LED Lamp	25000	CCT	1050	Dia:60 H:111mm
INL-35728	12W LED B22 GLS LED Lamp	25000	CCT	1050	Dia:60 H:111mm





STANLEY

WORKSITE

A professional range of robust, high output and long lasting LED site lighting.

SECURITY LIGHTS	284-291
HEAD TORCHES	292-295
HAND TORCHES	296-299
SITE LIGHTING	300-321

SLIMLINE

LED Floodlight

UPTO
16500
LUMENS

IP65

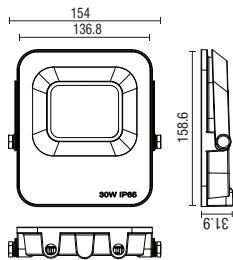

- Die-cast aluminium with polycarbonate diffuser
- Pre wired with 500mm cable
- Horizontal & Vertical adjustment on bracket
- 25,000 hours lifetime



Code	Power (w)	Total Flux (lm)	Weight	Dimensions
SXLS38687E	20W LED	2200	0.32kg	H:120 W:120 Proj:33mm
SXLS38688E	30W LED	3300	0.55kg	H:158 W:154 Proj:33mm
SXLS38689E	50W LED	5500	0.78kg	H:193 W:183 Proj:33mm
SXLS38690E	100W LED	11000	1.24kg	H:233 W:218 Proj:33mm
SXLS38691E	150W LED	16500	1.8kg	H:268 W:248 Proj:33mm

SLIMLINE

LED Floodlight with PIR Sensor

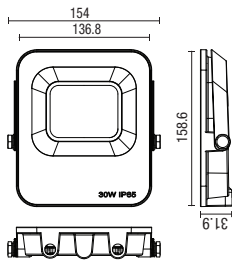

- Die-cast aluminium with polycarbonate diffuser
- Pre wired with 500mm cable
- Horizontal & Vertical adjustment on bracket
- 25,000 hours lifetime
- PIR sensor with adjustable LUX sensitivity and timer
- 12m Detection Distance



Code	Power (w)	Total Flux (lm)	Weight	Dimensions
SXLS38693E	20W LED	2200	0.35kg	H:190 W:120 Proj:54mm
SXLS38694E	30W LED	3300	0.78kg	H:193 W:183 Proj:54mm
SXLS38695E	50W LED	5500	1.24kg	H:233 W:218 Proj:54mm
SXLS38696E	100W LED	11000	1.8kg	H:268 W:248 Proj:54mm
SXLS38697E	150W LED	16500	1.83kg	H:350 W:250 Proj:54mm

FROSTED

LED Floodlight

UPTO
4500
LUMENS

IP65



- Die-cast aluminium with frosted polycarbonate diffuser
- Horizontal & Vertical adjustment on bracket
- 25,000 hours lifetime



IP65
Rated



180°
Beam



6500K
DW



Class 1

Code	Power (w)	Total Flux (lm)	Weight	Dimensions
SXLS38927E	10W LED	900	0.32kg	H:80 W:117 Proj:55mm
SXLS38928E	20W LED	1800	0.4kg	H:100 W:150 Proj:55mm
SXLS38929E	30W LED	2700	0.55kg	H:120 W:185 Proj:55mm
SXLS38930E	50W LED	4500	0.7kg	H:145 W:215 Proj:55mm

FROSTED

LED Floodlight with PIR Sensor

MANUAL
OVERRIDE





UPTO
4500
LUMENS

IP54





- Die-cast aluminium with frosted polycarbonate diffuser
- Horizontal & Vertical adjustment on bracket
- Adjustable timer, LUX and sensitivity
- 25,000 hours lifetime

PIR
Sensor

IP54
Rated

180°
Beam

6500K
DW

Class 1

Code	Power (w)	Total Flux (lm)	Weight	Dimensions
SXLS38933E	10W LED	900	0.32kg	H:150 W:117 Proj:70mm
SXLS38934E	20W LED	1800	0.4kg	H:155 W:150 Proj:75mm
SXLS38935E	30W LED	2700	0.55kg	H:185 W:185 Proj:75mm
SXLS38936E	50W LED	4500	0.77kg	H:205 W:215 Proj:55mm

DIECAST

LED Floodlight

UPTO
3500
LUMENS

IP65



- Die-cast aluminium with frosted polycarbonate diffuser
- Pre wired with 500mm cable
- Horizontal & Vertical adjustment on bracket
- 25,000 hours lifetime



Code	Power (w)	Total Flux (lm)	Weight	Dimensions
SXLS38937E	10W LED	700	0.21kg	H:105 W:105 Proj:45mm
SXLS38938E	20W LED	1400	0.35kg	H:130 W:130 Proj:45mm
SXLS38939E	30W LED	2100	0.51kg	H:165 W:165 Proj:45mm
SXLS38940E	50W LED	3500	0.72kg	H:200 W:200 Proj:45mm

DIECAST

LED Floodlight with PIR Sensor



- Die-cast aluminium with frosted polycarbonate diffuser
- Pre wired with 500mm cable
- Adjustable timer, LUX and sensitivity
- Horizontal & Vertical adjustment on bracket
- 25,000 hours lifetime

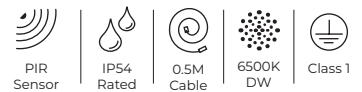

Code	Power (w)	Total Flux (lm)	Weight	Dimensions
SXLS38941E	10W LED	700	0.25kg	H:160 W:105 Proj:78mm
SXLS38942E	20W LED	1400	0.42kg	H:185 W:130 Proj:78mm
SXLS38943E	30W LED	2100	0.57kg	H:215 W:165 Proj:78mm
SXLS38944E	50W LED	3500	0.78kg	H:240 W:200 Proj:78mm

SLIMLINE

LED Floodlight

UPTO
8000
LUMENS

IP65



- Die-cast aluminium
- Pre wired with 500mm cable
- 180° beam angle
- Angled bracket for easy installation



Code	Power (w)	Total Flux (lm)	Weight	Dimensions
SXLS343544KBE	10W LED	800	0.18kg	H:120 W:103 Proj:65mm
SXLS312944KBE	20W LED	1600	0.41kg	H:162 W:159 Proj:85mm
SXLS312954KBE	30W LED	2400	0.41kg	H:162 W:159 Proj:85mm
SXLS312964KBE	50W LED	4000	0.74kg	H:180 W:205 Proj:115mm
SXLS317644KBE	100W LED	8000	1.37kg	H:230 W:270 Proj:142mm

SLIMLINE

LED Floodlight with PIR



UPTO
4000
LUMENS

IP65



- Die-cast aluminium
- Pre wired with 500mm cable
- 180° beam angle
- Angled bracket for easy installation
- PIR sensor with adjustable LUX sensitivity and timer
- 12m Detection Distance
- Hrs: 20,000



Code	Power (w)	Total Flux (lm)	Weight	Dimensions
SXLS343594KBE	10W LED	800	0.23kg	H:140 W:103 Proj:148mm



HEAD TORCH

LED with Magnet

IP20

- 3 x AAA Duracell batteries included
- Working time minimum 5 hours
- Magnetic side for static use
- 25 Meter beam distance
- Two power settings (100%, 50%)
- Adjustable head strap
- Aluminium



DURACELL

Code	Colour Temp	Total Flux (lm)	Dimensions
SXLS50100E	5000-7000K	300	H:40 W:88 H:38mm

HEAD TORCH

LED Zoom

IP20

- 3 x AAA Duracell batteries included
- Working time minimum 6 hours
- Magnetic side for static use
- 150 Meter beam distance
- Two power settings (100%, 50%)
- Adjustable head strap
- Aluminium



DURACELL

Code	Colour Temp	Total Flux (lm)	Dimensions
SXLS50101E	5000-7000K	300	H:48 W:65 H:54mm

RECHARGEABLE HEAD TORCH

LED



- USB C charging port and cable
- Five power settings (100%, 75%, 50%, 25%, dual function)
- Wave sensor control
- 110 beam distance
- Working time 8 hours
- Charging time 3 hours
- Polycarbonate



Code	Colour Temp	Total Flux (lm)	Dimensions
SXLS43188E	6000-8000K	650	H:42 W:70 H:39mm



HEAD TORCH

LED

IP20

NEW



- 120 Lumen head torch with adjustable head strap
- 3 x AAA duracell batteries included
- 10 meter beam
- Working Time - 3-5 hours

Code	Colour Temp	Total Flux (lm)	Dimensions
SXLS50107E	6000K	120	H:40 W:88 H:38mm

RECHARGEABLE HEAD TORCH

LED



IP44

NEW



- Dual function rechargeable head torch
- SMD front area light & side LED focus light
- On/off and wave sensor operation
- Lithium-ion long lasting rechargeable battery cells
- Three power settings (100%, 50%, 25%, flash)

Code	Colour Temp	Total Flux (lm)	Dimensions
SXLS50109E	6000K	300	H:40 W:88 H:38mm



HAND TORCH

500 lumen

IPX4

NEW

- 2 x AA Duracell batteries included
- 100 Meter beam distance
- Adjustable zoom control
- Three power settings (100%, 50%, flash)
- Working time 4 hours
- Focus beam design
- Aluminium



DURACELL

Code	Colour Temp	Total Flux (lm)	Dimensions
SXLS43183E	6000K	500	H:160 W:33 H:33mm

HAND TORCH

1000 lumen

IPX4

NEW

- 4 x AA Duracell batteries included
- 100 Meter beam distance
- Adjustable zoom control
- Three power settings (100%, 50%, flash)
- Working time 6 hours
- Focus beam design
- Aluminium



DURACELL

Code	Colour Temp	Total Flux (lm)	Dimensions
SXLS43184E	6000K	1000	H:171 W:45 H:45mm

RECHARGEABLE HAND TORCH

500 lumen

IP44

NEW

- USB C charging port and cable
- Working time up to 28 hours.
- Charging time 5 hours
- Three power settings (100%, 50%, 25%, flash)
- 430 Meter beam distance
- Focus beam design
- Aluminium



Code	Colour Temp	Total Flux (lm)	Dimensions
SXLS43185E	6000K	500	H:162 W:36.5 H:36.5mm



ADJUSTABLE HAND TORCH

LED 600 lumen

600
LUMENS

IP44

- Aluminium construction
- Push button ON/OFF switch with 3 modes (low 45lm/high 600lm/flash)
- Rotating adjustable focus
- Beam projects up to 270m
- Battery lasts up to 20 hours on low, 2 hours on high brightness
- Supplied with Duracell batteries



DURACELL

Code	Power (w)	Total Flux (lm)	Weight	Batteries
SXLS50102E	5W LED	45/600	0.155kg	4 x 1.5V AAA (included)

ADJUSTABLE HAND TORCH

LED 800 lumen

800
LUMENS

IP44

- Aluminium construction
- Push button ON/OFF switch with 3 modes (low 50lm/high 800lm/flash)
- Rotating adjustable focus
- Beam projects up to 260m
- Battery lasts up to 50 hours on low, 18 hours on high brightness
- Supplied with Duracell batteries



DURACELL

Code	Power (w)	Total Flux (lm)	Weight	Batteries
SXLS50103E	7W LED	50/800	0.305kg	3 x 1.5V C (included)

ADJUSTABLE HAND TORCH

LED 350 lumen

350
LUMENS

IP44

- Aluminium construction
- Push button ON/OFF switch with 3 modes (low 25lm/high 350lm/flash)
- Rotating adjustable focus
- Beam projects up to 175m
- Battery lasts up to 25 hours on low, 4 hours on high brightness
- Supplied with Duracell batteries



Code	Power (w)	Total Flux (lm)	Weight	Batteries
SXLS50105E	3W LED	25/350	0.085kg	3 x 1.5V AAA (included)

ADJUSTABLE HAND TORCH

LED 280 lumen

280
LUMENS

IP44

- Aluminium construction
- Push button ON/OFF switch with 3 modes (low 25lm/high 280lm/flash)
- Rotating adjustable focus
- Beam projects up to 150m
- Battery lasts up to 25 hours on low, 4 hours on high brightness
- Supplied with Duracell batteries



Code	Power (w)	Total Flux (lm)	Weight	Batteries
SXLS50106E	3W LED	50/800	0.081kg	2 x 1.5V AA (included)

RECHARGEABLE HAND TORCH

Adjustable LED 650 lumen

650
LUMENS

IP44

- Aluminium construction
- Rechargeable USB-C port with charge indicator Red (charging) Green (charged)
- Push button ON/OFF switch with 3 modes (low 350lm/high 650lm/flash)
- Rotating adjustable focus
- Beam projects up to 240m
- Battery lasts up to 9 hours on low, 5 hours on high brightness
- Charge time 4.5hrs



Code	Power (w)	Total Flux (lm)	Weight	Batteries
SXLS50104E	5W CREE LED	350/650	0.156kg	1 x 3.7V 2200mAh Rechargeable

Magnetic Portable Rechargeable Worklight



- USB C charging port and cable: The worklight can be conveniently charged using a USB C port and cable, allowing for easy charging with compatible devices
- Ultra strong magnetic base
- Three power modes (100%, 50%, off): The worklight offers three different power modes, allowing the user to adjust the brightness according to their needs
- Working time 4 hours: The worklight can operate continuously for up to 4 hours on a single charge, providing ample lighting for various tasks
- Charging time 3 hours: The worklight can be fully charged in approximately 3 hours, ensuring minimal downtime between uses
- Polycarbonate body
- IP54: The worklight has an IP54 rating, indicating that it is protected against dust and water splashes, making it suitable for use in various environments



Code	Colour Temp	Lumens	Dimensions
SXLS50114E	5700K	1000	L93 x W38 x H105mm

Rechargeable Worklights



- USB C charging port and cable
- USB output allowing mobile phone charging capabilities
- Tripod mountable using Stanley universal tripod code: SXLS37627E See page 298
- Working time 8 hours
- Charging time 3.5 hours
- IP54 waterproof
- Polycarbonate body

Code	Colour Temp	Lumens	Dimensions
SXLS50118E	5700K	1500	L184 x W40 x H135mm
SXLS50119E	5700K	3000	L221 x W53 x H209mm
SXLS50120E	5700K	5000	L276 x W64 x H260mm

Universal Tripod

- Height adjustable up to 1.7m allowing for versatile positioning
- Wide sturdy base providing stability and support
- Universal clasp fitting & 8mm thread fitting
- Made from aluminium, for durability and strength
- Universal Tripod compatible with SXLS50115E, SXLS50116E, SXLS50117E, SXLS50118E, SXLS50119E, SXLS5020E, SXLS37952E, SXLS37180E, and SXLS36986E
- L1400 x W1320 x H1320mm



Code

SXLS37627E

COMPATIBLE LIGHTS



SXLS50118E



SXLS50115E



SXLS37951E



SXLS36986E



SXLS36986E

Mains Worklight

IP54

NEW



- ON / OFF only
- Tripod mountable using Stanley universal tripod code: SMLS37627E See page 298
- 220-240v 50/60 Hz: The worklight operates on mains power with a voltage range of 220-240v and a frequency of 50/60 Hz
- Diffuser to ensure comfortable working illumination
- IP54 waterproof
- Polycarbonate body

Code	Power (W)	Colour Temp	Lumens	Dimensions
SXLS50115E	20W	5700K	2000	L219 x W52 x H157mm
SXLS50116E	40W	5700K	4000	L221 x W53 x H209mm
SXLS50117E	80W	5700K	8000	L276 x W64 x H260mm

TWIN LED

Work Light with Tripod

PACK
INCLUDES
WORKLIGHT
& TRIPOD

60W
LED

5200
LUMENS

IP65



- NEW improved Twin LED work light with extendable heavy duty tripod
- Tripod has a bar clamp for fast secure fitting and a built in cord wrap
- 2m H05RN-F 3G 1.0mm cable
- 2 x 30W SMD LED for powerful energy efficient light



3M
Cable



IP65
Rated



6000K
DW



Class 1



4.45kg

Code	Voltage	Lamp	Lumen	Dimensions
SXLS34624/31333LE	220-240V	2 x 30W LED	5200	Dia:1160 H:1170/1700mm

RECHARGEABLE

Work Light



UPTO
1500
LUMENS

IP54



- Rechargeable SAMSUNG battery cells
- Durable ABS with heavy duty rubber surround
- 25% / 50% / 100% / OFF brightness modes
- USB C fast charging cable
- 2 hours run time at full brightness, 25% = 8 hours, 50% = 5 Hours, 100% = 3 Hours
- Charge time = 4 hours
- 25,000 hours LED lifetime

 Recharge- able	 IP54 Rated	 6000K DW	 Class 1	 0.76kg
--	--	--	--	---

Code	Voltage	Battery	Lamp	Lumen	Dimensions
SXLS31329E	220-240V	3.7V 4400mAh	10W LED	1000	L:58 W:158 H:225mm



360° AREA

Tower Light

80W
LED

8400
LUMENS

IP54



- 180° and 360° directional light heads helps prevent light wastage or pollution
- Telescopic pole with manual quick release handles for speedy height adjustment
- Adjustable height from 1.5 to 2m
- Integrated carry handle
- Each head can be switched ON/OFF independently
- 3m H05RN-F 3C 1.5mm cable
- 1 x external socket outlet



3M
Cable



IP54
Rated



6500K
DW



Class 1



5.6kg

Code	Power (w)	Colour (k)	Total Flux (lm)	Dimensions
SXLS37182E	80W	6500	8600	H:1500-2000 Dia:920mm

PLASTERERS

Area Work Light

50W
LED

4000
LUMENS

IP54



- Durable ABS / PC body with steel legs
- Foldable stand and carry handle
- 2m H05RN-F 3G 1.5mm cable
- 1 x external socket outlet
- 50W LED module (SMD)
- K: 6000
- Lm: 4000
- Lm/W: 80



2M
Cable



IP54
Rated



6000K
DW



Class 1



2.65kg

Code	Voltage	Lamp	Lumen	Dimensions
SXLS37673E	240V	50W LED	4000	L:880 W:880 H:1070mm

TWIN

2 x 20W Worklight

40W
LED

4500
LUMENS

IP65



- Durable steel frame and die-cast aluminium body
- Frosted shatterproof lens
- Light can be angled exactly where needed
- 2m H05RN-F 3G 1.5mm cable
- Tripod mountable



Code	Power (w)	Colour (k)	Total Flux (lm)	Dimensions
SXLS37951E	2 x 20W	4000	4500	L:175mm W:485mm H:315mm

PORTABLE

Work Light

UPTO
4000
LUMENS

IP44



- Durable steel frame and die-cast aluminium body
- Frosted shatterproof lens
- Light can be angled exactly where needed
- 1.5m H05RN-F 3G 1.0mm cable



Code	Power (w)	Colour (k)	Total Flux (lm)	Weight (kg)	Dimensions
SXLS36383E	20W	4000	1800	1kg	L:115 W:190 H:290mm
SXLS36384E	30W	4000	2700	1.25	L:145 W:220 H:320mm
SXLS36385E	50W	4000	4500	1.45	L:185 W:250 H:330mm

FOLDING

Work Light

UPTO
3600
LUMENS

IP65



- Durable steel frame and die-cast aluminium body
- Frosted shatterproof lens
- Foldable stand for easy storage and transportation
- 1.5m H05RN-F 3G 1.0mm cable



Code	Power (w)	Colour (k)	Total Flux (lm)	Weight (kg)	Dimensions
SXLS35525E	20W	4000	1500	0.93	L:165 W:225 H:275mm
SXLS35526E	30W	4000	2200	1.28	L:185 W:250 H:335mm
SXLS35527E	50W	4000	3600	1.7	L:185 W:280 H:375mm

AREA

Work Light

120W
LED

8400
LUMENS

IK10

IP65



- Durable polycarbonate body
- Heavy duty shockproof base
- 360° beam angle for shadow free illumination
- 5m H05RN-F 3G 1.5mm cable
- IK10 vandal resistant
- 120W LED module (SMD)
- K: 6000
- Lm/W: 70



Code	Voltage	Lamp	Lumen	Dimensions
SXLS31324ES	110V	120W LED	8400	L:349 W:347 H:436mm

RECHARGEABLE

Folding Worklight



50W
LED

UPTO
5500
LUMENS

IP65



- Lithium-Ion long lasting rechargeable battery cells
- Durable steel frame and die-cast aluminium body
- Battery: 6 x 3.7V 2600mAh
- 20% / 60% / 100% / OFF brightness modes
- Run time
 - 100% - 4 hours
 - 60% 9 hours
 - 20% 12 hours
- 5-6 hours charge time
- 25,000 hours LED lifetime

Rechargeable

IP65 Rated

6000K DW

Class 3

1.65kg

Code	Power (w)	Colour (k)	Total Flux (lm)	Dimensions
SXLS37177E	20W	6000	2200	L:185 W:229 H:285mm
SXLS37178E	30W	6000	3300	L:195 W:260 H:320mm
SXLS37179E	50W	6000	5500	L:220 W:300 H:385mm

MAGNETIC & LINKABLE

Globe Area Light

30W
LED

2600
LUMENS

IP54



- 3m H07RN-F 3G 1.5mm cable
- 1 x external socket outlet
- Magnetic base
- Hanging hook
- Can be mounted on Stanley Universal Tripod



Code	Voltage	Lamp	Lumen	Dimensions
SXLS36986E	220-240V	30W LED	2600	H:260 W:200 D:210mm

PORTABLE

Work Light

35W
LED

2100
LUMENS

IP44



- Durable ABS / PC body
- Heavy duty rubber surround
- Folding carry handle acts as a stand and wall mountable fixture
- 5m H05RN-F 3G 1.5mm cable
- 1 x external socket outlet
- 35W LED module (SMD)
- K: 6000
- Lm: 2100
- Lm/W: 70



5M
Cable



IP44
Rated



6000K
DW



Class 2



2.24kg

Code	Voltage	Lamp	Lumen	Dimensions
SXLS31326E	220-240V	35W LED	2100	L:120 W:270 H:275mm

PANEL

Work Light

50W
LED

4000
LUMENS

IK10



- Durable ABS / PC body
- Heavy duty shockproof base with moulded carry handle
- IK10 impact resistant for tough working environments
- 2 x external socket outlets
- 5m H05RN-F 3G 1.5mm cable
- 50W LED module (SMD)
- Lm/W: 80



5M
Cable



IK10



IP44
Rated



6000K
DW



Class 1



2.96kg

Code	Voltage	Lamp	Lumen	Dimensions
SXLS31325ES	110V	50W LED	4000	L:150 W:300 H:465mm

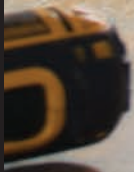

WORK LIGHT

33W
LED

4000
LUMENS

IP65



- Durable die-cast aluminium and steel
- Floorstanding or can be tripod mounted
- 50% / 100% / OFF brightness modes
- 2m H05RN-F 3C 1.5mm cable
- 33W LED module (SMD)
- K: 6000
- Lm: 4000
- Lm/W: 80
- Hrs: 20,000



2M
Cable



IP65
Rated



6000K
DW



Class 2



1.9kg

Code	Voltage	Lamp	Lumen	Dimensions
SXLS31331E	220-240V	33W LED	4000	L:183 W:215 H:330mm

TWIN WORK LIGHT

33W
LED

8000
LUMENS

IP65



- Durable die-cast aluminium and steel
- Floorstanding or can be tripod mounted
- 50% / 100% / OFF brightness modes
- 2m H05RN-F 3C 1.5mm cable
- 2 x 33W ED module (SMD)
- K: 6000
- Lm: 8000
- Lm/W: 80
- Hrs: 20,000



2M
Cable



IP65
Rated



6000K
DW



Class 2



1.9kg

Code	Voltage	Lamp	Lumen	Dimensions
SXLS31332E	220-240V	2 x 33W LED	8000	L:183 W:540 H:370mm

FOLDING

Work Light

UPTO
3900
LUMENS

IP65



- Durable die-cast body with plastic protective bumpers
- Foldable stand for easy storage and transportation
- 1.8m H05RN-F 3G 1.0mm cable



Code	Voltage	Lamp	Lumen	Weight	Dimensions
SXLS31334E	220-240V	10W LED	800	1.6kg	L:235 W:276 H:283mm
SXLS31335E	220-240V	20W LED	1500	1.7kg	L:245 W:292 H:295mm
SXLS31336E	220-240V	30W LED	2100	1.84kg	L:255 W:332 H:295mm
SXLS31337E	220-240V	50W LED	3900	1.92kg	L:255 W:322 H:295mm

RECHARGEABLE

Folding Work Light



UPTO
1800
LUMENS

IP65



- Durable die-cast body with plastic protective bumpers
- 30% / 50% / 100% / OFF brightness modes
- Foldable stand for easy storage and transportation
- 1.5m H05RN-F 3G 1.0mm charging cable
- USB charging port with Android & IOS compatibility



Code	Battery	Charge-Time	Run-Time (100%)	Lamp	Lumen	Weight	Dimensions
SXLS31338E	2 x 2200mAh	3 Hours	3 Hours	8W LED	600	1.6kg	L:235 W:276 H:283mm
SXLS31340E	6 x 2200mAh	4.5 Hours	3 Hours	24W LED	1800	1.8kg	L:255 W:332 H:295mm

Multi Directional Work Light

50W
LED

4500
LUMENS

IP54



- 3 Lighting Heads (Side lights adjustable)
- 1.5M H05RN-F 3G 1.5mm cable
- 3 Switch modes 4500LM / 2250LM / OFF
- Quick release mechanism
- Can be mounted on Stanley Universal Tripod



Code	Power (w)	Colour (k)	Total Flux (lm)	Dimensions
SXLS37180E	50W	6000	2600	H:235mm (w/o handle) W:405mm D:185mm

+44 (0) 161 359 4949 | info@forumlightingsolutions.com | forumlightingsolutions.com



LED FESTOON

10 Light

80W
LED

7100
LUMENS

IP44



- Available in 110v and 240v versions with corresponding plug types
- Product length 22meters
- 10 x 8w LED modules
- 7100 lumens
- 710 lumens per module



22M
Cable



IP44
Rated



6500K
DW



Class 1



7.76kg

Code	Voltage	Lamp	Lumen	Dimensions (Each Head)
SXLS31362ES	110V	10 x 8W LED	10 x 710	H:67 Dia:115mm
SXLS31362E	240V	10 x 8W LED	10 x 710	H:67 Dia:115mm





ELECTRALITE

COMMERCIAL

Installer friendly range of quality Commercial lighting, including our range of LED tapes, drivers and profiles, downlights, and battens.

LED STRIP	322-329
LED STRIP ACCESSORIES	330-333
UNDER CABINET LIGHTS	334-335
RECESSED/DOWNLIGHTS	336-341

PROFESSIONAL 24V LED STRIPS

3M 200MP

3M 200MP high performance acrylic adhesives used on all professional LED strips.

Our high grade 24V LED strips are ideal if you require 5 metres or more in a single length. Built from the highest specification components, they are consistent in brightness and reliability as there is less current. Therefore less voltage drop and less wiring is required. 24V strips or tapes are the choice of the professional installer.

How to choose an LED strip

1. Choose LED type

Choose from White LED (single colour), or RGBW LED (16 selectable colour options). Available in a range of different variants to suit all applications.

2. Choose colour temperature

Choose from warm white, cool white and daylight white LED colour temperatures to suit your application. For RGB skip to step 3.

3. Choose installation environment

Select the protection you require for the installation environment. Choose from IP65 water resistant LED strip for wet areas or IP20 non water resistant LED strip for dry areas.

4. Choose profile

Designed to hold your LED strip, providing diffusion and protection. We offer a range of profiles, including surface mounted, recessed and corner mounted.

5. Choose your driver

Calculate the overall wattage of the LED strip to be used. Then select the driver that is higher in wattage than your LED strip (tape).

6. Accessories

We offer strip connectors and strip live-end connectors for our full range of LED strip, enabling you to cut and size your strip for any application or even extend LED strip where required.

7. Remote control receivers

Remote controlled receivers offer precise and user-friendly control over integral LED strip lighting, allowing you to change the colour and brightness of your room with the touch of a finger.

IP20 8MM 6W

LED Strip



- 24V to avoid voltage drop on longer runs
- IP20 for use indoor
- 3M self-adhesive backing
- Strips can be cut, linked or joined at copper contacts
- Requires LED driver
- 30,000 Hours lifespan
- Dimmable with receiver / controller (pages 332-334)

5m
50m



Code	LED Colour	Kelvin	Lumen / Metre	Power W /Metre	LEDs / Metre	LED Type	Strip Width	CRI	Roll Length
ELA-34280	Warm White	2700K	525	5.76W p/m	60	SMD2835	8mm	>80	5m
ELA-34281	Cool White	4000K	588						50m
ELA-34857	Warm White	2700K	525						5m
ELA-34858	Cool White	4000K	588						50m

IP65 8MM 6W

LED Strip



- 24V to avoid voltage drop on longer runs
- IP65 for use outdoor
- 3M self-adhesive backing
- Strips can be cut, linked or joined at copper contacts
- Requires LED driver
- 30,000 Hours lifespan
- Dimmable with receiver / controller (pages 332-334)

5m
50m



Code	LED Colour	Kelvin	Lumen / Metre	Power W / Metre	LEDs / Metre	LED Type	Strip Width	CRI	Roll Length
ELA-34283	Warm White	2700K	525	5.76W p/m	60	SMD2835	8mm	>80	5m
ELA-34284	Cool White	4000K	588						50m
ELA-34860	Warm White	2700K	525						50m
ELA-34861	Cool White	4000K	588						50m

IP20 10MM RGB 12W LED Strip



- 24V to avoid voltage drop on longer runs
- IP20 for use indoor
- 3M self-adhesive backing
- Strips can be cut, linked or joined at copper contacts
- Requires LED driver
- 30,000 Hours lifespan
- Dimmable with RGB remote control & receiver (pages 332-334)

5m
50m



Code	LED Colour	IP Rating	Lumen / Metre	Power W /Metre	LEDs / Metre	LED Type	Strip Width	CRI	Roll Length
ELA-34290	RGB	IP20	1000	11.52W p/m	60	SMD5050	10mm	>80	5m
ELA-34871									50m

IP65 10MM RGB 12W LED Strip



- 24V to avoid voltage drop on longer runs
- IP65 for use outdoor
- 3M self-adhesive backing
- Strips can be cut, linked or joined at copper contacts
- Requires LED driver
- 30,000 Hours lifespan
- Dimmable with RGB remote control & receiver (pages 332-334)

5m
50m



Code	LED Colour	IP Rating	Lumen / Metre	Power W /Metre	LEDs / Metre	LED Type	Strip Width	CRI	Roll Length
ELA-34291									5m
ELA-34872	RGB	IP65	1000	11.52W p/m	60	SMD5050	10mm	>80	50m

IP65 12MM RGB/CCT 19.2W LED Strip



- 24V to avoid voltage drop on longer runs
- IP65 for use outdoor
- 3M self-adhesive backing
- Strips can be cut, linked or joined at copper contacts
- Requires LED driver
- 30,000 Hours lifespan
- Dimmable with RGB/CCT remote control & receiver (pages 332-334)

5m
50m



Code	LED Colour	IP Rating	Lumen / Metre	Power W / Metre	LEDs / Metre	LED Type	Strip Width	CRI	Roll Length
ELA-34296	RGB/CCT	IP65	1000	19.2W p/m	60	SMD5050	12mm	>80	5m
ELA-34873									50m



COB IP20 8MM 12W

LED Strip



- 24V to avoid voltage drop on longer runs
- IP20 for use indoor
- 3M self-adhesive backing
- Strips can be cut every 62.5mm
- More flexible than SMD LED strip
- Spot free lighting array
- Very high colour rendering index producing true light colour RA>90. RA90
- Dimmable with receiver (pages 332-334)

5m
50m



Code	LED Colour	Kelvin	Lumen / Metre	Power W /Metre	LEDs / Metre	LED Type	Strip Width	CRI	Roll Length
ELA-35750	Warm White	3000K	896	12W p/m	512	COB	8mm	>90	5m
ELA-35751	Cool White	4000K	934						50m
ELA-35752	Warm White	3000K	896						50m
ELA-35753	Cool White	4000K	934						50m

ALUMINIUM PROFILES



· Fits 8mm, 10mm & 12mm LED Strip

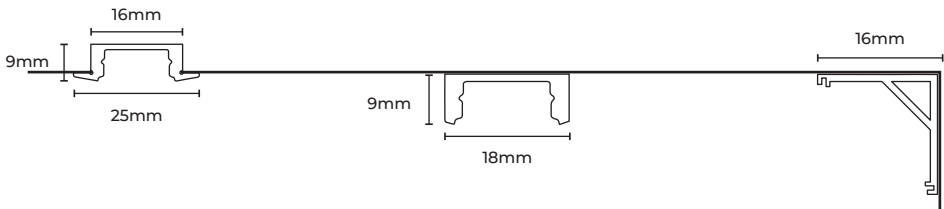

Recessed



ELA-34308

Surface-mount



ELA-34306

Corner



ELA-34307

Code	Description	Dimensions
ELA-34308	Aluminium Recessed Profile	L:2000 W:25 Proj:9mm
ELA-34306	Aluminium Surface-mount Profile	L:2000 W:18 Proj:9mm
ELA-34307	Aluminium 45° Corner Surface-mount Profile	L:2000 W:16 Proj:16mm

LED DRIVERS

Constant Voltage

ELA-36974



ELA-36975



ELA-34302



ELA-34301



ELA-34303



ELA-34300



ELA-34304



ELA-34305



Code	Description	Weight	Dimensions
ELA-36974	LED Driver Constant Voltage 24V 10W	-	-
ELA-36975	LED Driver Constant Voltage 24V 20W	-	-
ELA-34300	LED Driver Constant Voltage 24V 36W	0.13kg	H:48mm W:45mm L:140mm
ELA-34301	LED Driver Constant Voltage 24V 60W	0.17kg	H:20mm W:40mm L:140mm
ELA-34302	LED Driver Constant Voltage 24V 100W	0.24kg	H:28mm W:61mm L:178mm
ELA-34303	IP67 LED Driver Constant Voltage 24V 60W	0.42kg	H:30mm W:58mm L:200mm
ELA-34304	IP67 LED Driver Constant Voltage 24V 150W	0.81kg	H:58mm W:82mm L:260mm
ELA-34305	IP67 LED Driver Constant Voltage 24V 200W	0.81kg	H:58mm W:82mm L:260mm

5 in 1 Wifi DC Controller



RGB/CCT LED Strip Controller & Remote Control



- Kit includes Remote and controller
- RF (radio frequency) not IR (infra-red)
- Touch wheel for easy colour change
- RGB & CCT function
- Over 16 million colours to choose from
- Pre-set dynamic mode
- 0-100% brightness
- 30 meter control distance

Code	Dimensions
ELA-38126	L:120 W:44 H:27

Code	Dimensions
ELA-34297	L:120 W:44 H:27mm

LED RECEIVERS

Remote Control



ELA-34292

ELA-34293



ELA-34286

ELA-34287

- Remote and controller are RF (radio frequency) not IR (infra-red)
- Compatible with single colour/RGB/RGBW LED strip
- Smooth dimming and switch without any flickering

- Remote and controller are RF (radio frequency) not IR (infra-red)
- Compatible with single colour LED strip
- Smooth dimming and switch without any flickering

Code	Description	Dimensions
ELA-34286	1 Channel LED Receiver	H:20 W:37 L:115mm
ELA-34287	1 Zone Programmable Remote Control	H:9 W:59 L:107mm
ELA-34292	4 Channel RGB LED Receiver	H:20 W:37 L:115mm
ELA-34293	4 Zones Programmable RGB/W Remote Control	H:9 W:59 L:107mm

LED STRIP CONNECTORS

Solder Free



ELA-41718



ELA-41719



ELA-41721



ELA-41720



ELA-41722



ELA-41723



ELA-41725



ELA-41724



ELA-41726



ELA-41727



ELA-41729



ELA-41728

Code	Description	Fits
ELA-41718	Wire To Strip Connector 2PIN 8MM PCB	8mm Strip
ELA-41719	Strip To Strip Connector Easy Fit 2PIN 8MM PCB	
ELA-41720	Strip To Wire to Strip Connector 2PIN 8MM PCB	
ELA-41721	Wire To Strip Connector Easy Fit 2PIN 8MM PCB	
ELA-41722	Wire To Strip Connector 4PIN 10MM PCB	10mm Strip
ELA-41723	Strip To Strip Connector Easy Fit 4PIN 10MM PCB	
ELA-41724	Strip To Wire To Strip Connector 4PIN 10MM PCB	
ELA-41725	Wire To Strip Connector Easy Fit 4PIN 10MM PCB	
ELA-41726	Wire To Strip Connector 6PIN 12MM PCB	12mm Strip
ELA-41727	Strip To Strip Connector Easy Fit 6PIN 12MM PCB	
ELA-41728	Strip To Wire To Strip Connector 6PIN 12MM PCB	
ELA-41729	Wire To Strip Connector Easy Fit 6PIN 12MM PCB	



BODHI

CCT Adjustable Under Cabinet Link Light



Ultra slim LED under cabinet lights ideal for kitchen, cabinet, cove lighting or other applications. Linkable end-to-end or using link leads available separately.

- White PC body with opal diffuser
- Switchable between 3000K/4000K/6000K
- ON/OFF rocker switch
- No driver required
- C7 cable type
- Supplied with 2m power lead
- Versatile and simple to install
- Can be mounted horizontally or vertically
- Energy efficient and long life

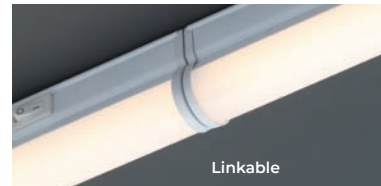

Code	Description	Power (w)	Colour (k)	Total Flux (lm)	Weight	Length	Dimensions
ELA-41712	Bodhi Link Light	5W LED	3 CCT	500	0.34kg	312mm	L:312 W:22 Proj:36mm
ELA-41713		9W LED	3 CCT	900	0.172kg	611mm	L:611 W:22 Proj:36mm
ELA-41714		14W LED	3 CCT	1300	0.210kg	911mm	L:911 W:22 Proj:36mm
ELA-41715		18W LED	3 CCT	1700	0.246kg	1210mm	L:1210 W:22 Proj:36mm
ELA-21665	Bodhi Link Lead 8 Type	-	-	-	0.30kg	500mm	Length: 500mm
ELA-21666		-	-	-	0.52kg	1000mm	Length: 1000mm



338

ELECTRALITE COMMERCIAL

YATE

Adjustable Fire Rated Downlight

FAST
FIT

IP20



• Fast-fit connector box

- 30, 60 and 90 minutes protection
- Suitable for homes with low ceilings
- Available in 6 finishes



Code	Finish	IP Rating	Lamp	Cutout	Dimensions
ELA-27466-WHT	White				
ELA-27466-CHR	Chrome				
ELA-27466-BCHR	Black Chrome				
ELA-27466-SCHR	Satin Chrome	IP20	1 x 7W max LED GU10	Ø85mm	Dia:93 Proj:120 H:135mm
ELA-27466-MBLK	Matt Black				
ELA-27466-SATBRS	Satin Brass				

YATE

Fixed Fire Rated Downlight

FAST
FIT

IP20



- 30, 60 and 90 minutes protection
- Suitable for homes with low ceilings
- Available in 6 finishes

- Fast-fit connector box



Code	Finish	IP Rating	Lamp	Cutout	Dimensions
ELA-27465-WHT	White				
ELA-27465-CHR	Chrome				
ELA-27465-BCHR	Black Chrome				
ELA-27465-SCHR	Satin Chrome	IP20	1 x 7W max LED GU10	Ø72mm	Dia:80 Proj:115 H:135mm
ELA-27465-MBLK	Matt Black				
ELA-27467-SATBRS	Satin Brass				

YATE

Fixed IP65 Fire Rated Downlight

FAST
FIT

IP65



· Fast-fit connector box

- 30, 60 and 90 minutes protection
- Suitable for homes with low ceilings
- Available in 6 finishes



Code	Finish	IP Rating	Lamp	Cutout	Dimensions
ELA-27467-WHT	White				
ELA-27467-CHR	Chrome				
ELA-27467-BCHR	Black Chrome				
ELA-27467-SCHR	Satin Chrome	IP65	1 x 7W max LED GU10	Ø85mm	Dia:80 Proj:115 H:125mm
ELA-27467-MBLK	Matt Black				
ELA-27467-SBRS	Satin Brass				

RHOM

IP65 Fixed Fire-rated Downlight



- Dimmable
- Fire rated
- Colour changing technology
- Switch between 3000K/4000K/6000K
- Fast fit terminals
- Available in 7 finishes
- 8W LED module (SMD)
- Lm: 900
- Lm/W: 112.5
- CRI: 80
- Hrs: 50,000



Fire-rated



IP65 Rated



60° Beam



70mm Cut-out



CCT



Class 2



0.15kg

Code	Pack Size	Finish	Power (W)	Total Flux (lm)	Efficiency (lm/W)	Colour (k)	Dimensions
SPA-38572-ACOP		Antique Copper					
SPA-38572-BCHR		Black Chrome					
SPA-38572-CHR		Chrome					
SPA-38572-MWHT	Single	Matt White	8W	900	112.5	CCT	Dia:87mm H:65mm
SPA-38572-SBLK		Satin Black					Cutout:70mm
SPA-38572-SBRS		Satin Brass					
SPA-38572-SNIC		Satin nickel					

COMO

IP65 Tiltable Fire-rated Downlight

FAST
FIT

700
Lumens

IP65



- Dimmable
- Fire rated
- 30mm Super low profile
- Fast fit terminals
- Available in 5 finishes
- 5W LED module (SMD)
- K: 4000
- Lm: 500
- Lm/W: 100
- CRI: 80
- Hrs: 50,000



Code	Finish	Power (W)	Total Flux (lm)	Efficiency (lm/W)	Colour (k)	Dimensions
SPA-38571-ACOP	Antique Copper	5W	500	100	4000	Dia:87mm H:30mm Cutout:70mm
SPA-38571-CHR	Chrome					
SPA-38571-MWHT	Matt White					
SPA-38571-SBLK	Satin Black					
SPA-38571-SBRS	Satin Brass					





SHOWROOM SUPPORT

At Forum we offer a variety of Point of Sale and Marketing material, from counter top to wall board and ceiling displays.

Please contact your Area Sales Manager or speak to the Forum Sales office for more details.



INFORMATION

LIGHTING TERMS

Bathroom Zone

Suitability for a product to be installed near or in water.

CCT

Correlated Colour Temperature

Colour Switchable

Colour temperature can be switched between 3000K to 4000K or 6000K.

Cool White (CW) 4000K

Light with a CCT kelvin temperature of 4000K.

Daylight White (DW) 6000K

Light with a CCT kelvin temperature of 6000K.

Downlight

A luminaire designed to be installed in a ceiling, with the light source pointed vertically downwards.

Floodlight

A luminaire featuring a wide beam angle, designed to provide illumination over a wide area.

IK Rating

Indicates the protection against mechanical impact. Rated from IK00 to IK10.

IP Rating

Ingress Protection Rating.

Kelvin (K)

Kelvin is the scientific unit for measuring CCT.

LED (Light Emitting Diode)

Emits light through the conversion of electrical energy.

Lifetime

The definition of LED luminaire lifetime is the period in hours after which the luminaire no longer delivers the correct amount of light, either insufficient light is produced or none at all. This may be a combination of many factors not limited to just the LED performance.

Lumens (lm)

The quantity of light emitted from a light source that is visible. The higher the lumens, the brighter the light.

LUX

A measure of the intensity of light, defined as 1lm /m².

Microwave Sensor

An active intrusion sensor that

detects the movement of a person or object through a pattern of microwave energy

Photocell

Sometimes known as a dusk to dawn sensor. The sensor reacts to the ambient light and will turn the fitting on when a pre-set light level is reached

PIR Sensor

Passive Infrared Device, used to activate lighting when a person enters a room or area.

Power Supply / Driver

Power source for the LED luminaire.

RGB

Red, Green, Blue. Used to describe colour changing products that can be used to dynamically add colour to any environment.

RGBW

Stands for Red, Green, Blue, White. Used to describe colour changing products that can be used to

dynamically add colour to any environment. Can also be run on white when natural lighting is required.

Spotlight

A light source featuring a narrow beam angle, designed to allow highlighting or illumination of specific features in an area.

Task Lighting

Lighting specifically designed to provide functional illumination of an environment.

Warm White (WW) 3000K

Light with a CCT kelvin temperature of 3000K.

Watt (W)

The unit of electrical power stating the amount of electricity consumed by the product.

Work Lighting

Lighting specifically designed to provide functional illumination of a work site environment.

COLOUR TEMPERATURE

GUIDE

LEDs make it possible to have a choice of white colours or 'tones'. This allows easy customisation of an area to bring out the best in the materials and design of a room. With standard white LED lighting, these tones range from warm-yellow, to daylight-blue light, with options in between. The graphic below is a reference that starts at a warm yellow colour on the left and fades into a blue colour on the right.

Colour temperature ratings describe the tones of white light available. Colour temperature options range from 2000-3000K for Warm White lighting, 3100-4500 for Cool White lighting and 4600-6500 for Daylight White lighting. It can be a tricky decision to know what is best for your installation, but our skilled technical sales team are on hand to guide you through choosing the perfect colour temperature for your room.



Colour temperature	2000-3000K	3100-4500K	4600-6500K
Light appearance	Warm White	Cool White	Daylight White
Best for	Warmer whites are generally preferred for creating a more relaxed environment in dining, living or reception areas	Cool white is a good choice for retail and office environments where a simulated natural, outdoor light is preferred. Use in contemporary kitchens and bathrooms to complement décor	Perfect for industrial, security, garages and task lighting where the most natural lighting is required

IP RATING

INGRESS PROTECTION

Ingress protection rating (IP); this relates to the degree of protection the light provides against solid objects and water ingress. IP ratings are relevant to anywhere that moisture is prevalent, such as bathrooms, utility rooms and outdoor environments. Written as IPXX, the first X denotes the level of protection offered from solid objects; the second X denotes the level of protection offered from moisture. The higher the numbers are, the better the protection will be.

SOLID OBJECTS

0	No special protection
1	Protection from a large part of the body such as a hand (but no protection from deliberate access); from solid objects greater than 50mm in diameter
2	Protection against fingers or other objects not greater than 80mm in length and 12mm in diameter
3	Protection from entry by tools, wires etc, with a diameter of 2.5mm or more
4	Protection against solid bodies larger than 1mm
5	Protection against solid objects that may harm equipment
6	Totally dust-tight; no ingress of dust

LIQUIDS

0	No special protection
1	Protected against dripping water; vertically falling drops
2	Protected against vertical falling drops of water with enclosure tilted up to 15 degrees from the vertical; limited ingress permitted
3	Protected against sprays of water up to 60 degrees from the vertical; limited ingress permitted
4	Protection from splashing water from any direction
5	Protection against low pressure water jets (all directions)
6	Protection against high pressure water jets and waves
7	Protection against temporary immersion
8	Watertight against the effects of immersion in water under pressure for long periods

Ingress protection ----- **IP65**

BATHROOM ZONING

WHAT IS BATHROOM ZONING?

All bathroom lighting installations must comply to the guidelines set out in Amendment 1 of the 17th edition of the IEE Wiring Regulations (BS7671). The bathroom is divided into zones, with prescribed minimum IP ratings for the light fittings in each zone. To illustrate IP zoning regulations, the bathroom area is divided up into areas or 'ZONES'. Light fittings are then assigned an 'IP rating' which indicates how much protection they provide against ingress of water and other particles. Each zone has a minimum IP requirement that must be met if a fitting is to be installed in this area.

Zone 0 \geq IPX7

Inside bath or shower. Only 12V AC rms or 30V ripple-free DC SELV fittings with a minimum rating of IPX7 (protected against immersion in water). Transformers must be sited outside Zones 0,1,2.

Zone 1 \geq IPX5

The area above the bath or shower up to a height of 2.25 metres. Fittings must be rated at IPX5 or higher (protected from jets of water).

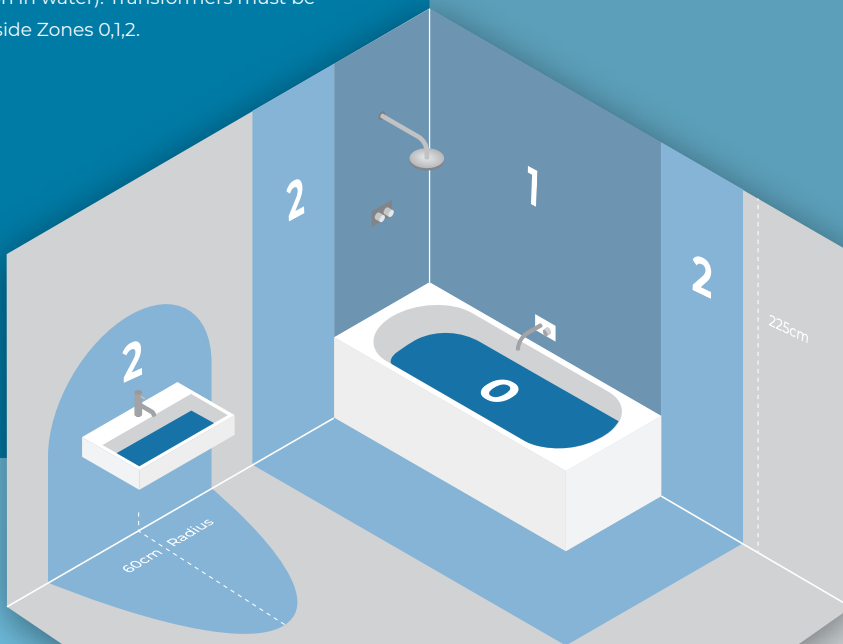

Zone 2 \geq IPX4

Covers an area 0.6 metres wide immediately next to, and all around Zone 1. The 60cm area around washbasins should also be treated as zone 2. The minimum rating is IPX4. If there is a likelihood of water jets being used for cleaning purposes in Zone 2, a minimum of IPX5 is required.

Outside Zones 0, 1 & 2

Covers any area outside Zones 0, 1 and 2. There is no IP requirement in this zone. Bathrooms are allowed to contain a socket outlet, this must be located 3 metres outside Zone 1. Lighting circuits and any socket-outlet circuit in a room containing a bath and/or shower must be provided with 30mA RCD protection.

INDEX ALPHABETICAL

Any typographical, clerical or other error or omission in any sales literature, quotation, price list, acceptance of offer, invoice or other document or information issued by the Company shall be subject to correction without any liability on the part of the Company. Goods supplied may vary in detail from the illustrations, drawings, measurements and descriptions set out in the Company's sales literature, which are approximate and for guidance only and will not form part of the Contract. Colour finishes will be maintained as accurately as possible but matching cannot be guaranteed. All terminology used in the Company's sales literature is, subject to these Conditions, that as understood by general usage in the trade. For full terms and conditions of sale consult your distributor.

CUL-21624	235	CUL-37783	248	CZ-29321-BLK	164	ELA-34300	333	INL-31776-WHT	266
CUL-21625	235	CUL-37784	248	CZ-29321-SST	164	ELA-34301	333	INL-31789-ACOP	271
CUL-21626	234	CUL-37785	248	CZ-31740-BLK	158	ELA-34302	333	INL-34028-AMB	275
CUL-21637	251	CUL-37786	247	CZ-31743-BLK	157	ELA-34303	333	INL-34029-AMB	275
CUL-21638	251	CUL-37787	245	CZ-31744-BLK	162	ELA-34304	333	INL-34030-AMB	275
CUL-21639	251	CUL-37788	245	CZ-31745-BLK	157	ELA-34305	333	INL-34150-3K	280
CUL-21643	253	CUL-37791	254	CZ-31746-BLK	158	ELA-34306	332	INL-34150-4K	280
CUL-21645	253	CUL-37792	254	CZ-31747-BLK	169	ELA-34307	332	INL-34151-3K	280
CUL-21647	253	CUL-37793	254	CZ-31748-BLK	147	ELA-34308	332	INL-34151-4K	280
CUL-21649	253	CUL-37794	254	CZ-31750-BLK	156	ELA-34857	325	INL-34400	281
CUL-21651	253	CUL-37795	244	CZ-31752-BLK	169	ELA-34858	325	INL-34401	281
CUL-21656	252	CUL-37797	243	CZ-31806-BLK	168	ELA-34860	326	INL-35728	281
CUL-21658	252	CUL-37798	243	CZ-31811-BLK	150	ELA-34861	326	INL-36012	278
CUL-21660	251	CUL-40031-65	6	CZ-31812-BLK	150	ELA-34871	327	INL-36013	278
CUL-21665	239	CUL-40032-65	6	CZ-33397-BLK	154	ELA-34872	328	INL-36014	278
CUL-21666	239	CUL-40033-65	6	CZ-33461-BLK	151	ELA-34873	329	INL-36015	278
CUL-25218	235	CUL-40034-65	6	CZ-34014-BLK	155	ELA-35750	246/331	INL-36016	278
CUL-25219	234	CUL-40035-65	6	CZ-34015-BLK	155	ELA-35751	246/331	INL-36017	278
CUL-25317	235	CUL-40036-65	6	CZ-34016-BLK	156	ELA-35752	331	INL-37211	258
CUL-25318	235	CUL-40037	6	CZ-34017-BLK	156	ELA-35753	331	INL-37213	258
CUL-25319	234	CUL-40038	6	CZ-35704-BLK	159	ELA-36974	333	INL-37214	258
CUL-26332	251	CUL-40039	6	CZ-35705-BLK	159	ELA-36975	333	INL-37219	260
CUL-26333	251	CUL-40040	6	CZ-35742-BLK	147	ELA-38126	334	INL-37220	261
CUL-26334	251	CUL-42495	7	CZ-37501-ANTH	160	ELA-41712	337	INL-37221	260
CUL-26335	251	CUL-42496	7	CZ-37501-RUST	160	ELA-41713	337	INL-37222	261
CUL-26336	253	CUL-42497	7	CZ-37502-ANTH	160	ELA-41714	337	INL-37223	261
CUL-26337	253	CUL-42498	7	CZ-37502-RUST	160	ELA-41715	337	INL-37224	260
CUL-26338	253	CUL-42499	7	CZ-37503-ANTH	161	ELA-41718	335	INL-37225	259
CUL-26339	253	CUL-42500	7	CZ-37503-RUST	161	ELA-41719	335	INL-37226	259
CUL-26340	253	CUL-42501	7	CZ-38639-ANTH	149	ELA-41720	335	INL-38609	262
CUL-26341	253	CUL-42502	7	CZ-38639-BLK	149	ELA-41721	335	INL-38610	262
CUL-26342	253	CUL-44403-BLK	249	CZ-44225-BLK	152	ELA-41722	335	INL-38612	262
CUL-26344	252	CUL-44403-WHT	249	CZ-44226-BLK	152	ELA-41723	335	INL-38617-BLK	267
CUL-26345	252	CUL-44404-SBRS	249	CZ-44370-BLK	169	ELA-41724	335	INL-38617-BRS	267
CUL-26346	251	CUL-44405-SNIC	249	ELA-21665	337	ELA-41725	335	INL-38617-SIL	267
CUL-26465	76/255	CUL-44764	7	ELA-21666	337	ELA-41726	335	INL-38617-WHT	267
CUL-26465-WW	76/255	CUL-44765	7	ELA-27465-BCHR	340	ELA-41727	335	INL-38618-BLK	267
CUL-30710	253	CUL-44766	6	ELA-27465-CHR	340	ELA-41728	335	INL-38618-BRS	267
CUL-30711	253	CUL-44767	7	ELA-27465-MBLK	340	ELA-41729	335	INL-38618-SIL	267
CUL-33996-BLK	253	CUL-44836	5	ELA-27465-SATBRS	340	INL-27988-ABRS	269	INL-38618-WHT	267
CUL-34223-CCT	240	CUL-44838	5	ELA-27465-SCHR	340	INL-27988-ACOP	269	INL-41730-BLK	249
CUL-34224-CCT	240	CUL-44839	5	ELA-27465-WHT	340	INL-27988-ARZ	269	INL-41730-WHT	249
CUL-34225-CCT	240	CUL-44840	5	ELA-27466-BCHR	339	INL-27988-PEW	269	INL-41731-BLK	250
CUL-35860	237	CUL-44842	5	ELA-27466-CHR	339	INL-27988-SNIC	269	INL-41731-WHT	250
CUL-35861	237	CUL-44843	5	ELA-27466-MBLK	339	INL-28203-BCHR	264	INL-42264	279
CUL-35864	236	CUL-44844	5	ELA-27466-SATBRS	339	INL-28205-BCHR	265	INL-42265	279
CUL-35865	237	CUL-44845	5	ELA-27466-SCHR	339	INL-28573	279	INL-42266	279
CUL-37386	241	CZ-20947-BLK	153	ELA-27466-WHT	339	INL-28574	279	INL-42267	279
CUL-37387	241	CZ-25142-BLK	153	ELA-27467-BCHR	341	INL-28575	279	INL-42270	279
CUL-37388	241	CZ-25143-BLK-65	163	ELA-27467-CHR	341	INL-28576	279	INL-42271	279
CUL-37389	241	CZ-25144-BLK-65	162	ELA-27467-MBLK	341	INL-28577	279	INL-42272	279
CUL-37768	247	CZ-25145-BLK	146	ELA-27467-SATBRS	341	INL-28578	279	INL-42273	279
CUL-37769	247	CZ-25148-BLK	144	ELA-27467-SCHR	341	INL-29464-CW	280	INL-42276	279
CUL-37770	247	CZ-25149-BLK	145	ELA-27467-WHT	341	INL-29464-WW	280	INL-42277	279
CUL-37771	247	CZ-25150-BLK	146	ELA-34280	325	INL-29465-CW	280	INL-42278	279
CUL-37772	248	CZ-26743-BLK	147	ELA-34281	325	INL-31723-BLK	266	INL-42279	279
CUL-37773	248	CZ-29191-ATR	165	ELA-34283	326	INL-31723-SBRS	266	INL-42282	279
CUL-37774	248	CZ-29192-ATR	167	ELA-34284	326	INL-31723-SNIC	266	INL-42283	279
CUL-37775	248	CZ-29193-ATR	167	ELA-34286	334	INL-31723-WHT	266	INL-42284	279
CUL-37776	248	CZ-29319-ANTH	164	ELA-34287	334	INL-31775-BLK	265	INL-42285	279
CUL-37777	248	CZ-29319-BLK	164	ELA-34290	327	INL-31775-SBRS	265	INL-598310-SNIC	264
CUL-37778	248	CZ-29319-SST	164	ELA-34291	328	INL-31775-SNIC	265	INL-598410-SNIC	263
CUL-37779	248	CZ-29320-ANTH	163	ELA-34292	334	INL-31775-WHT	265	INL-740000-SNIC	263
CUL-37780	248	CZ-29320-BLK	163	ELA-34293	334	INL-31776-BLK	266	INL-A60-LED-ES-TNT	277
CUL-37781	248	CZ-29320-SST	163	ELA-34296	329	INL-31776-SBRS	266	INL-C35L-LED-SES-CLR	277
CUL-37782	248	CZ-29321-ANTH	164	ELA-34297	334	INL-31776-SNIC	266	INL-C35L-LED-SES-TNT	277

INL-G80-LED-ES-CLR	276	SPA-35714	206	SPA-PR-12744	209	ZN-33615-WHT	107	ZN-42039	124
INL-G80-LED-ES-TNT	276	SPA-35715	206	SPA-PR-13145-MBLK	214	ZN-33994-BLK	66	ZN-42040	125
INL-G95-LED-ES-CLR	277	SPA-35716	206	SPA-PR-17146	210	ZN-34018-SBLK-65	27	ZN-42041	125
INL-G95-LED-ES-TNT	277	SPA-35717	207	ZN-15136-SST	50	ZN-34018-SST-65	27	ZN-42042	130
INL-ST64-LED-BC-CLR	276	SPA-35718	207	ZN-15871-SST	50	ZN-34019-ANTH	48	ZN-42043	122
INL-ST64-LED-BC-TNT	276	SPA-35719	208	ZN-20930-BLK	15	ZN-34020-ANTH	48	ZN-42044	122
INL-ST64-LED-ES-CLR	276	SPA-35720	208	ZN-20941-ANTH-65	23	ZN-34022-SBLK-65	28	ZN-42045	126
INL-ST64-LED-ES-TNT	276	SPA-35721	208	ZN-20941-BLK-65	23	ZN-34022-SST-65	28	ZN-42046	126
SPA-19713-CHR	189	SPA-35722	208	ZN-20941-COP-65	23	ZN-34043-ANTH	45	ZN-42047	126
SPA-19713-SBRS	189	SPA-35723	211/268	ZN-20941-SST-65	23	ZN-34043-ANTH	45	ZN-42048	127
SPA-20182-CHR	190	SPA-35724	211/268	ZN-20941-WHT-65	23	ZN-34870	83	ZN-42049	127
SPA-20182-SBRS	190	SPA-35725	211/268	ZN-20941-POLSST-65	23	ZN-35072-BLK	21	ZN-42050	135
SPA-20829-MBLK	192	SPA-35726	211/268	ZN-20944-ANTH	56	ZN-35593-BLK	47	ZN-42051	133
SPA-20829-SBRS	192	SPA-35727	211/268	ZN-20944-BLK	56	ZN-35594-BLK	47	ZN-42052	133
SPA-22560	201	SPA-35811-CHAMP	181	ZN-20945-BLK	55	ZN-35685-BLK	47	ZN-42053	133
SPA-22560-MBLK	201	SPA-35811-CHR	181	ZN-20955-BLK	65	ZN-35686-BLK	47	ZN-42054	131
SPA-24468-CHR	186	SPA-35812-BLK	180	ZN-20957-BLK	63	ZN-35688-BLK	79	ZN-42055	131
SPA-24869-CHR	187	SPA-35814-BLK	180	ZN-20965-BLK	71	ZN-35688-DGRY	79	ZN-42057	137
SPA-27405-BRS	200	SPA-35836-SBRS	181	ZN-20965-SST	71	ZN-35688-WHT	79	ZN-42058	139
SPA-27405-CHR	200	SPA-35843-SBRS	184	ZN-23454-BLK	80	ZN-35690-WHT	39	ZN-42059	138
SPA-27405-MBLK	200	SPA-36129-CHR	183	ZN-23454-WHT	80	ZN-35738-BLK	70	ZN-42060	140
SPA-28326-CHR	191	SPA-36129-MBLK	183	ZN-25151-BLK	108	ZN-35741-BLK	35	ZN-42066-BLK	18
SPA-30841-BRCOP	268	SPA-36130-MBLK	184	ZN-25152-BLK	113	ZN-37052-BLK	128	ZN-42095-BLK	18
SPA-30841-MBLK	268	SPA-36140-CHR	185	ZN-25152-WHT	113	ZN-37938-ANTH-65	29	ZN-42229	141
SPA-30841-MWHT	268	SPA-36140-MBLK	185	ZN-25153-WHT	111	ZN-37938-BLK-65	29	ZN-43121-SST	14
SPA-30842-CHR	268	SPA-36300-CHR	192	ZN-25154-WHT	110	ZN-37940-ANTH-65	29	ZN-43344-ANTH	31
SPA-30842-SBRS	268	SPA-36310-CHR	182	ZN-25155-WHT	111	ZN-37940-BLK-65	29	ZN-43344-RST	31
SPA-30842-SCHR	268	SPA-38571-ACOP	175/343	ZN-25156-BLK	114	ZN-37940-SST-65	29	ZN-44218-ANTH	12
SPA-30993-CHR	212/ 273	SPA-38571-CHR	175/343	ZN-25340-SST	67	ZN-38205-ANTH	52	ZN-44219-ANTH	13
SPA-30993-MBLK	212/ 273	SPA-38571-MWHT	175/343	ZN-25463-BLK	68	ZN-38205-BLK	52	ZN-44223-BLK	11
SPA-30993-SBRS	212/ 273	SPA-38571-SBLK	175/343	ZN-25464-BLK	69	ZN-38599-BLK	109	ZN-44227-BLK	13
SPA-30993-SNIC	212/ 273	SPA-38571-SBRS	175/343	ZN-26536-ANTH-65	25	ZN-38600-WHT	109	ZN-44230-GLD	11
SPA-31306-CHR	195	SPA-38572-ACOP	173/342	ZN-26536-BLK-65	25	ZN-38602-BLK	54	ZN-44230-SIL	11
SPA-31306-MBLK	195	SPA-38572-BCHR	173/342	ZN-26536-COP-65	25	ZN-38621-BLK	37	ZN-44231-GLD	12
SPA-31309-CHR	195	SPA-38572-CHR	173/342	ZN-26536-SST-65	25	ZN-38622-BLK	39	ZN-44231-SIL	12
SPA-31309-MBLK	195	SPA-38572-MWHT	173/342	ZN-26536-WHT-65	25	ZN-38623-ANTH	36	ZN-44236-BLK	38
SPA-31725-SBRS	193	SPA-38572-SBLK	173/342	ZN-28708-BLK	67	ZN-38624-ANTH	36	ZN-44237-BLK	38
SPA-31726-SBRS	194	SPA-38572-SBRS	173/342	ZN-28708-SST	67	ZN-38630-BLK	67	ZN-44238-ANTH	38
SPA-31732-CHR	196	SPA-38572-SNIC	173/342	ZN-29177-WHT	110	ZN-38634-BLK	33	ZN-44239-ANTH	38
SPA-31733-CHR	196	SPA-38576-CHR	183	ZN-29179-ANTH-65	28	ZN-38636-ANTH	43	ZN-44245-ANTH	30
SPA-31736-CHR	197	SPA-38576-SBRS	183	ZN-29179-BLK-65	28	ZN-38637-BLK	33	ZN-44251-BLK	31
SPA-31736-MBLK	197	SPA-38576-TBLK	183	ZN-29179-SST-65	28	ZN-38640-MBLK	53	ZN-44260-ANTH	40
SPA-31737-CHR	198	SPA-38577-BRCOP	211/268	ZN-29180-BLK-65	27	ZN-39746-BLK	78	ZN-44260-BLK	40
SPA-31737-MBLK	198	SPA-39777-BLK	180	ZN-29180-SST-65	27	ZN-40001-ANTH	17	ZN-44262-ANTH	41
SPA-33931-CHR	188	SPA-39778-BLK	180	ZN-29181-BLK	15	ZN-40001-BLK	17	ZN-44262-BLK	41
SPA-33932-CHR	188	SPA-41111-BLK	172	ZN-29184-BLK	71	ZN-40002-ANTH	57	ZN-44263-ANTH	41
SPA-34008-WHT	205	SPA-41111-CHR	172	ZN-29185-WHT	114	ZN-40002-BLK	57	ZN-44263-BLK	41
SPA-34009-WHT	207	SPA-41111-SBRS	172	ZN-29186-WHT	115	ZN-40004-BLK/BRS	51	ZN-44264-ANTH	40
SPA-34010-SNIC	205	SPA-41111-SNIC	172	ZN-29187-WHT	115	ZN-40004-BLK/SST	51	ZN-44264-BLK	40
SPA-34011-SNIC	207	SPA-41111-WHT	172	ZN-29189-ATR	45	ZN-40065	75	ZN-44371	106
SPA-34012-CHR	205	SPA-41112-BLK/WHT	174	ZN-29190-ATR	45	ZN-41099-GRYSMK	20	ZN-44375	106
SPA-34013-CHR	207	SPA-41223-CHR	176	ZN-29347-ANTH	49	ZN-41100-GRYSMK	20	ZN-44411-BLK	14
SPA-34035	215	SPA-41224-SBRS	176	ZN-29347-BLK	49	ZN-41101-BRNZ	16	ZN-44553-BLK	10
SPA-34036	216	SPA-41225-SBLK	176	ZN-29993-BLK	32	ZN-41101-RBRS	16	ZN-44554-BLK	10
SPA-34037	217	SPA-41694-CHR	177	ZN-29995-BLK	34	ZN-41102-BRNZ	16	ZN-44555-BLK	10
SPA-34038	218	SPA-41694-MBLK	177	ZN-29996-BLK	34	ZN-41102-RBRS	16	ZR-32297-BLK	91
SPA-34039	219	SPA-41694-SNIC	177	ZN-29997-BLK	70	ZN-41106	77	ZR-32298-BLK	87
SPA-34047-BRS	202	SPA-44379-CHR	179	ZN-30508-BLK	81	ZN-41126	77	ZR-32299-BLK	89
SPA-34047-CHR	202	SPA-44380-SBRS	179	ZN-31385	82	ZN-41157	76	ZR-32300-BLK	101
SPA-34047-SBLK	202	SPA-44381-MBLK	179	ZN-31386	82	ZN-41158	76	ZR-32301-BLK	97
SPA-34047-SNIC	202	SPA-44384-CHR	179	ZN-31757-ANTH	61		20	ZR-32302-BLK	86
SPA-34050-BRS	203	SPA-44385-MBLK	179	ZN-31758-ANTH	42	ZN-41732	73	ZR-32328-BLK	98
SPA-34050-CHR	203	SPA-44386	222	ZN-31759-ANTH	42	ZN-41733	73	ZR-37441-BLK	100
SPA-34050-SBLK	203	SPA-44388	223	ZN-31767-BLK	36	ZN-41734	74	ZR-37442-GMTL	103
SPA-34050-SNIC	203	SPA-44391	225	ZN-31768-BLK	36	ZN-41735	74	ZR-37443-BLK	96
SPA-35080-BLK	199	SPA-44393	226	ZN-31805-WHT	114	ZN-41736	72	ZR-37444-BLK	99
SPA-35080-CHR	199	SPA-44396	228	ZN-31807-TBLK	66	ZN-41737	72	ZR-37445-BLK	105
SPA-35081-BLK	199	SPA-44397	228	ZN-31809-SST	64	ZN-41738	72/73/74	ZR-37448-BLK	104
SPA-35081-CHR	199	SPA-44466-BLK	197	ZN-32069-BLK	49	ZN-41739	72/73/74	ZR-38155-SIL	85
SPA-35706	221	SPA-44466-CHR	197	ZN-32070-ANTH	59	ZN-42019-SST	19	ZR-38156-BLK	95
SPA-35707	231	SPA-44482	229	ZN-32070-BLK	59	ZN-42031	119	ZR-38529-SIL	93
SPA-35709	206	SPA-44483	229	ZN-32255-BLK	21	ZN-42032	119	ZR-38532-SIL	92
SPA-35710	208	SPA-6888.014	213	ZN-33460-BLK-65	30	ZN-42033	121	ZR-38831-SIL	92
SPA-35711	205	SPA-6888.014BULBCOV	214	ZN-33579-BLK	108	ZN-42034	121	ZR-38833-BLK	94
SPA-35712	205	SPA-6888.014-SBLK	213	ZN-33579-WHT	108	ZN-42035	123	ZR-38834-BLK	94
SPA-35713	206	SPA-6888.014-SBRS	213	ZN-33615-BLK	107	ZN-42037	129		

ZINK

ZINK
SOLAR

COAST
OUTDOOR

Spa

CULINA



ELECTRALITE

INLIGHT

STANLEY

FORUM

LIGHTING SOLUTIONS

t +44 (0) 161 359 4949

f +44 (0) 161 628 2831

e info@forumlightingsolutions.com

Forum Lighting Solutions

Corse Mill, Corse Street, Oldham, OL9 9RJ, UK

forumlightingsolutions.com

 [linkedin.com/forumlightingsolutions](https://www.linkedin.com/company/forumlightingsolutions)



Scan to
view our
website

